



ELECTRIC VEHICLE CHARGER

EVC04 Series

Installation Guideline



CONTENTS

1 - SAFETY INFORMATION	4
1.1 - SAFETY WARNINGS	4
1.2- GROUNDING WARNINGS	5
1.3- WARNINGS ABOUT POWER CABLES, SOCKETS and RECHARGE CABLES	5
1.4 - WARNING FOR WALL INSTALLATION	6
2 - DESCRIPTION.....	6
2.1 - MODEL DESCRIPTION	6
2.2 - MODEL DESCRIPTION	7
3 - GENERAL INFORMATION.....	8
3.1 - INTRODUCTION TO PRODUCT COMPONENTS	8
3.2 - DIMENSIONAL DRAWINGS	9
3.2.1 - Model without display	9
3.2.2 - Model with display	9
4- EQUIPMENT, TOOLS and ACCESSORIES REQUIRED	10
5 - TECHNICAL SPECIFICATION.....	11
6- INSTALLING CHARGING STATION.....	13
6.1 - BOX CONTENTS FOR CHARGING STATION WITH SOCKET AND CABLE.....	13
6.2 - SUPPLIED INSTALLATION EQUIPMENT and ACCESSORIES.....	13
6.3 - PRODUCT INSTALLATION STEPS	15
6.3.1 - OPENING THE COVER OF THE CHARGING STATION	15
6.3.2 - WALL MOUNT INSTALLATION	16
6.3.3- SINGLE PHASE CHARGING STATION AC MAINS CONNECTION	19
6.3.4- THREE PHASE CHARGING STATION AC MAINS CONNECTION	20
6.3.5 - BROKEN PEN DETECTION FEATURE (Optional)	20
6.3.6 - ADJUSTING CURRENT LIMITER.....	21
6.3.7 - DIP SWITCH SETTINGS	22
6.3.7.1 - DATA CABLE CONNECTION	23
6.3.7.2 - EXTERNAL ENABLE INPUT FUNCTIONALITY.....	24
6.3.7.3 - LOCKED CABLE FUNCTION (Model With Socket).....	26
6.3.7.4 - POWER OPTIMIZER (REQUIRES OPTIONAL ACCESSORIES)	27
6.3.7.4.1 - Power optimizer with external MID meter	28
6.3.7.4.2 - POWER OPTIMIZER WITH EXTERNAL CURRENT TRANSFORMER (CT) (Optional).....	30
6.3.8 - MODE SELECTION SWITCH SETTINGS	31
6.3.9 - LOAD SHEDDING.....	32
6.3.10 - MONITORING OF WELDED RELAY CONTACTS FAILURE	33
6.3.11 - FACTORY RESET	34

6.3.12 - RESETTING LOCAL RFID CARD LIST AND REGISTERING NEW MASTER RFID CARD IN STANDALONE USAGE MODE	34
6.3.13 - SETTING ETHERNET PORT OF CHARGER TO STATIC IP IN STANDALONE USAGE MODE	35
6.3.14 - WEB CONFIGURATION INTERFACE ENABLE / DISABLE	36
6.3.15 - ETHERNET DAISY-CHAIN CONNECTION (OPTIONAL)	36
6.4 - OCPP CONNECTION	37
6.4.1 - CONNECT OCPP OVER CELLULAR NETWORK (Optional)	37
6.4.2 - CONNECT OCPP OVER ETHERNET	38
6.5 - COMMISSIONING	40
6.5.1 - CONNECT PC TO THE SAME NETWORK WITH SMART BOARD	41
6.5.2 - OPENING WEB CONFIGURATION INTERFACE WITH BROWSER	41
6.5.3 - OPENING THE WEB CONFIGURATION INTERFACE VIA WIFI HOTSPOT	43
6.6 - PRODUCT VARIANTS	44
6.6.1 - Default Setting “Standalone”	44
6.6.2 - Default Setting “E.ON Auto-Detect”	45
6.7 - WEB CONFIGURATION INTERFACE	46
6.7.1 - MAIN PAGE.....	46
6.7.2 - CHANGE GENERAL SETTINGS OF THE DEVICE	46
6.7.2.1 - Display Language	46
6.7.2.2 - Display Backlight Settings.....	47
6.7.2.3 - Led Dimming Settings	47
6.7.2.4 - Standby Led Behaviour	48
6.7.2.5 - Display Service Contact Info.....	48
6.7.2.6 - Logo Settings.....	49
6.7.2.7 - Display QR Code.....	49
6.7.2.8 - Scheduled Charging	50
6.6.3 - INSTALLATION SETTINGS	50
6.6.3.1 - Earthing system	50
6.6.3.2 - Current Limiter Settings	51
6.6.3.3 - Unbalanced Load Detection.....	52
6.6.3.4 - External Enabled Input.....	53
6.6.3.5 - Lockable Cable.....	53
6.6.3.6 - Charging Mode Selection and Power Optimizer Configuration	54
6.6.3.7 - Location	54
6.6.3.8 - Load Shedding Minimum Current:	55
6.6.4 - CHANGE OCPP SETTINGS OF THE DEVICE.....	55
6.6.5 - CHANGE NETWORK INTERFACES SETTINGS OF THE DEVICE	57
6.6.6 - CHANGE STANDALONE MODE SETTINGS OF THE DEVICE.....	59

6.6.7 - LOCAL LOAD MANAGEMENT OF THE DEVICE	60
6.6.7.1 - Modbus TCP/IP Protocol Parameters.....	60
6.6.7.2 - Static Management.....	60
6.6.7.3 - Dynamic Management	60
6.6.7.4 - Star Topology.....	61
6.6.7.4.1 - Static Supply Star Topology:	61
6.6.7.4.2 - Dynamic Supply Star Topology:	62
6.6.7.5 - Daisy Chain (Serial).....	62
6.6.7.5.1 - Static Supply Daisy Chain Topology:	62
6.6.7.5.2 - Dynamic Supply Daisy Chain Topology:.....	63
6.6.7.5.3 - Configuration of Slave Charging Stations	63
6.6.7.5.4 - Configuration of Master Charging Station.....	65
6.6.7.6 - Equally shared	69
6.6.7.7 - FiFo (First in - First Out)	69
6.6.7.8 - Combined Load Management.....	70
6.7.8 - MAKING SYSTEM MAINTANENCE OF THE DEVICE	73
6.7.9 - FIRMWARE UPDATE SCREEN (With display models).....	74
7 - UK REGULATION CHANGES ACCORDING TO SMART CHARGING (OPTIONAL)	77

1 - SAFETY INFORMATION



CAUTION
RISK OF ELECTRIC SHOCK



CAUTION: ELECTRIC VEHICLE CHARGER DEVICE SHALL BE MOUNTED BY A LICENSED OR AN EXPERIENCED ELECTRICIAN AS PER ANY REGIONAL OR NATIONAL ELECTRIC REGULATIONS AND STANDARDS IN EFFECT.



CAUTION



AC grid connection and load planning of the electric vehicle charging device shall be reviewed and approved by authorities as specified by the regional or national electric regulations and standards in effect.

For multiple electric vehicle charger installations the load plan shall be established accordingly. The manufacturer shall not be held liable directly or indirectly for any reason whatsoever in the event of damages and risks that are borne of errors due to AC grid supply connection or load planning.

IMPORTANT - Please read these instructions completely before installing or commissioning the device

1.1 - SAFETY WARNINGS

- Keep this manual in a safe place. These safety and operating instructions should be kept in a safe place for future reference.
- Check the voltage reported on the label; do not use the charging station without the appropriate supply voltage.
- If there is any doubt about normal operation or if the unit is damaged in any way, DO NOT continue using the unit; switch off the main power switches (MCB and RCCB). Contact your local dealer.
- The room temperature range should be approximately between +35°C and +55°C without direct sunlight and at a relative humidity between 5% and 95%. Use the charging station only within operating conditions.
- The position of the device must be chosen in such a way that excessive heating of the charging station is avoided. High operating temperatures, caused by direct sunlight or heating sources, may cause the charging current to be reduced or the charging process to be temporarily interrupted.
- The charging station is intended both for outdoor and indoor use. The device can also be used in public places.
- To reduce the risk of fire, electric shock or material damage, do not expose the unit to rain, snow, electrical storms or other severe weather events. Moreover, the charging station must not be exposed to splashes or spray of liquids.
- Do not touch the terminals, the electric vehicle connector and other hazardous live parts of the charging station with sharp metal objects.

- Avoid exposure to heat sources, and place the unit away from flammable, explosive, hard or combustible materials, chemicals or vapours.
- Risk of explosion. The equipment has internal flammable or spark-sensitive components that should not be exposed to flammable vapours. The unit should not be located in recessed spaces or below floor level.
- The device is designed solely for charging vehicles that do not require ventilation during loading.
- To avoid the risk of explosion and electric shock, make sure that the specified circuit breaker and earth leakage circuit breaker are connected to the network of the building.
- The lowest part of the socket should be between 0.5 m and 1.5 m above the ground.
- The use of adapters is not allowed. The use of extension cables is not allowed.



WARNING: Never let people (including children) with reduced physical, sensory or mental capabilities or lack of experience and or knowledge use electrical devices unsupervised.



CAUTION: This vehicle charger unit is intended only for charging electric vehicles not requiring ventilation during charging.

1.2- GROUNDING WARNINGS

- The charger must be connected to a grounded system. The earth conductor entering the loader must be connected to the instrument ground lug which is located inside the loader. This operation must be done with the circuit conductors and by connecting the equipment grounding bar or cable to the charging station. Connections to the loader are the sole responsibility of the installer and the purchaser.
- In order to reduce the risk of electric shock, connect only to earthed sockets.
- **WARNING:** Ensure that during installation and use the charging station is permanently and correctly grounded.

1.3- WARNINGS ABOUT POWER CABLES, SOCKETS and RECHARGE CABLES

- Check that the charging cable is a compatible Type 2 socket at the charging station.
- A damaged power cable can cause a fire or lead to electric shocks. Do not use the product if the flexible power cable or vehicle cable is frayed, if its insulation is damaged or if the unit shows other signs of damage.
- Therefore, please ensure that the charging cable is well positioned; do not step on it, do not trip over it or do not subject it to damage or stress.
- Do not forcibly pull on the cable and do not damage it with sharp objects.
- Never touch the vehicle plug/socket or cable with wet hands: this could cause a short circuit or an electric shock.
- In order to avoid the risk of fire or electric shock, do not use the device with extension cords. To avoid danger, if the mains cable or vehicle cable is damaged, it must be replaced by the manufacturer, its service agent or by similarly qualified persons.

1.4 - WARNING FOR WALL INSTALLATION

- Please carefully read the instructions before mounting the wall charging station.
- Do not install the charging station on the ceiling or on sloping walls.
- Use the indicated wall mounting screws and other accessories.
- The unit is certified to be used both indoors and outdoors. If the unit is mounted outdoors, the equipment for connecting the hoses to the unit must be certified for outdoor use and must also be installed in such a way that the IP certification on the unit is maintained.

2 - DESCRIPTION

2.1 - MODEL DESCRIPTION

Model Name	<p>MODEL DESCRIPTION: EVC04-E*-*-*</p> <p>EVC04 : Electric Vehicle AC Charger (Mechanical Cabinet 04) E: E.ON</p> <p>1st Asterisk (*) : Rated Power</p> <p>7 : 7.4 kW (1Phase Supply Equipment) 11 : 11 kW (3Phase Supply Equipment) 22 : 22 kW (3Phase Supply Equipment)</p> <p>2nd Asterisk (*) can include combinations of the following options. RFID reader is standard equipment for all of the model variants</p> <p>W : Wi-Fi module or Wi-Fi & Bluetooth module L : LTE / 3G / 2G module P : ISO 15118 PLC HLC module CT : Current transformer measurement module D : 4.3" TFT color display SC : Smart Charging PEN : Broken PEN detection and protection M : Charging unit with MID meter.</p> <p>3rd Asterisk (*) can be one of the following:</p> <p>S : Socket outlet C : Attached cable with Type-2 vehicle connector</p> <p>4th Asterisk (*) can include combinations of the following:</p> <p>Blank : B2B variant without RFID cards inside package R : B2B variant with RFID cards inside package</p>
Cabinet	EVC04

2.2 - MODEL DESCRIPTION

	LTE capable	SIM Card Integrated	WiFi	Display	Ethernet	MID Meter Integrated	ISO15118 prepared (PLC HLC)	Type2 AC Socket	Attached Cable	RCCB TypeA	DC6 mA Sensor	RFID Cards Attached	Broken PEN Detection	*Power Optimizer with External CT	Smart Charging
EVC04-E7-W-S			x		x			x			x	x			
EVC04-E7-W-C			x		x				5m		x	x			
EVC04-E7-WCTSCPEN-S			x		x			x			x	x	x	x	x
EVC04-E7-WCTSCPEN-C			x		x				5m		x	x	x	x	x
EVC04-E7-WCTPEN-C			x		x				5m		x	x	x	x	
EVC04-E7-WCTPEN-S			x		x			x			x	x	x	x	
EVC04-E11-W-S			x		x			x			x	x			
EVC04-E11-W-C			x		x				5m		x	x			
EVC04-E11-WDM-S			x	x	x	x		x			x				
EVC04-E11-WDM-C			x	x	x	x			5m		x				
EVC04-E22-WLDM-S	x	x	x	x	x	x		x			x				
EVC04-E22-WLDM-C	x	x	x	x	x	x			7m		x				
EVC04-E22-WLDM-S(R)	x	x	x	x	x	x		x			x	x			
EVC04-E22-WLDM-C(R)	x	x	x	x	x	x			7m		x	x			
EVC04-E22-WLPDM-S	x	x	x	x	x	x	x	x			x				
EVC04-E22-WLPDM-C	x	x	x	x	x	x	x		7m		x				
EVC04-E22-WLDSCM-S	x	x	x	x	x	x		x			x				x
EVC04-E22-WLDSCM-C	x	x	x	x	x	x			7m		x				x

* Depends on customer request, CT can be ordered separately and can be connected to embedded Power Optimizer board.

3 - GENERAL INFORMATION

3.1 - INTRODUCTION TO PRODUCT COMPONENTS

Models with socket



Models with integrated cable



EN Socket Models

- 1- Information Display (Optional)
- 2- RFID Card Reader
- 3- Status indicator LED
- 4- MID Meter Display (Optional)
- 5- Socket Outlet
- 6- Product Label
- 7- Charging station communication cable gland nut
- 8- Charging station communication cable gland nut
- 9- Charging station supply inlet gland nut

EN Tethered Cable Models

- 1- Information Display (Optional)
- 2- RFID Card Reader
- 3- Status indicator LED
- 4- MID Meter Display (Optional)
- 5- Dummy Socket
- 6- Charging Plug
- 7- Product Label
- 8- Charging cable
- 9- Charging station communication cable gland nut
- 10- Charging station supply inlet gland nut

3.2 - DIMENSIONAL DRAWINGS



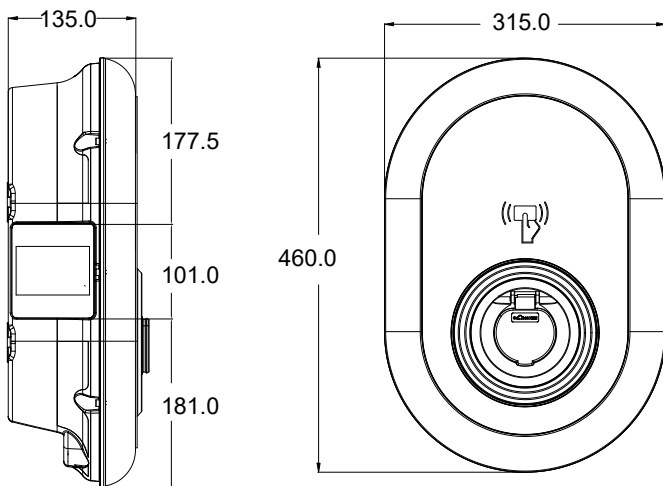



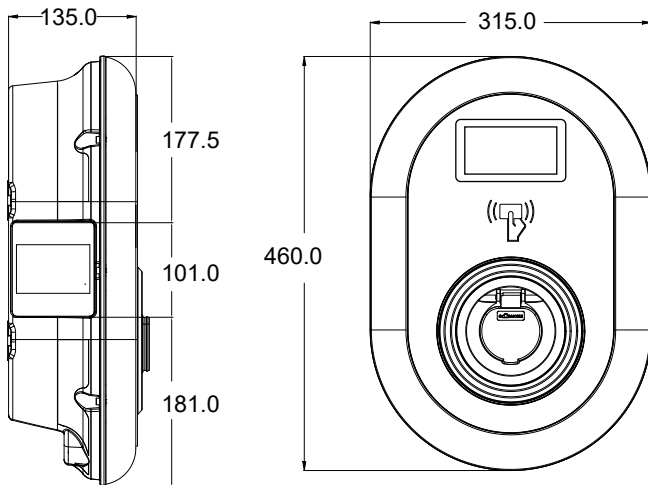



3.2.1 - Model without display



3.2.2 - Model with display



4- EQUIPMENT, TOOLS and ACCESSORIES REQUIRED

		
Drill bit 8 mm	Percussion drill	PC
		
Volt Indicator	Torx T25 security screwdriver	Water level
		
Flathead screwdriver (tip width 2.00-2.5 mm)	Pointed spudger	Right angle screwdriver adapter/Torx T20, safety tip
		
RJ45 crimping tool	Ethernet cable cat5e or cat6	

5 - TECHNICAL SPECIFICATION

This product is compliant to IEC61851-1 (Ed3.0) standard for Mode 3 use.

Model	EVC04-E22 Series	EVC04-E11 Series	EVC04-E7 Series
IEC Protection class	Class - I		
Vehicle Interface	Socket Model	Socket TYPE 2 (IEC 62196)	
	Cable Model	Cable with TYPE 2 (IEC 62196) Female Plug	
Voltage and Current Rates	400VAC 50/60 Hz - 3-phase 32A	400VAC 50/60 Hz- 3-phase 16A	230VAC 50/60 Hz - 1-phase 32A
Broken PEN Detection Voltage Range	NA	NA	<207V , >252V Single phase TN-C-S supplies only
AC Maximum Charge Output	22kW	11kW	7.4kW
Built-in Residual Current Sensing module	6mA		
Required Circuit Breaker on AC Mains	4P-40A MCB Type-C	4P-20A MCB Type-C	2P-40A MCB Type-C
Required Leakage Current Relay on AC Mains (for products which are not equipped with RCCB Type A)	4P -40A - 30mA RCCB Type-A	4P -20A - 30mA RCCB Type-A	2P -40A - 30mA RCCB Type-A
Required AC Mains Cable (Minimum)	5x 6 mm ² (< 50 m) External Dimensions: Ø 18-25 mm	5x4 mm ² (< 50 m) External Dimensions: Ø 18-25 mm	3x 6 mm ² (< 50 m) External Dimensions: Ø 13-18 mm

CONNECTIVITY

Ethernet	10/100 Mbps Ethernet (Standard with Smart Options)
Wi-Fi (Optional)	Wi-Fi 802.11 a/b/g/n/ac
Cellular (Optional)	LTE: B1 (2100 MHz), B3 (1800 MHz), B7 (2600 MHz), B8 (900 MHz), B20 (800 MHz), B28A (700 MHz) WCDMA: B1 (2100 MHz), B8 (900 MHz) GSM: B3 (1800 MHz), B8 (900 MHz)

OTHER FEATURES (Connected Models)

Diagnostics	Diagnostics over OCPP WebconfigUI
Software Update	Remote software update over OCPP WebconfigUI update Remote software update with server

AUTHORIZATION

RFID	ISO-14443A/B and ISO-15693
-------------	----------------------------

MECHANICAL SPECIFICATIONS

Material	Plastic
Product size	315 mm (Width) x 460 mm (Height) x 135 mm (Depth)
Dimensions (with package)	405 mm (Width) x 530 mm (Height) x 325 mm (Depth)
Product weight	5 kg for socket equipped model, 6,8kg for tethered cable model (3 Phases) 5,5kg for tethered cable model (1 Phase)
Weight with package	7,1 kg for socket equipped model, 8,9kg for tethered cable model (3 Phases) 7,6kg for tethered cable model (1 Phase)
AC Mains Cable Dimensions	For three-phase models Ø 18-25 mm For one-phase models Ø 13-18 mm
Cable Inlets	AC Mains / Ethernet / Modbus

ENVIRONMENTAL TECHNICAL SPECIFICATIONS

Protection Class	Ingress Protection Impact Protection	IP54 IK10 (Optional display have IK08 protection)
Usage Conditions	Temperature Humidity Altitude	-35 °C to 55 °C (without direct sunlight) 5% - 95% (relative humidity, non-condensing) 0 - 4,000m

6- INSTALLING CHARGING STATION

6.1 - BOX CONTENTS FOR CHARGING STATION WITH SOCKET AND CABLE

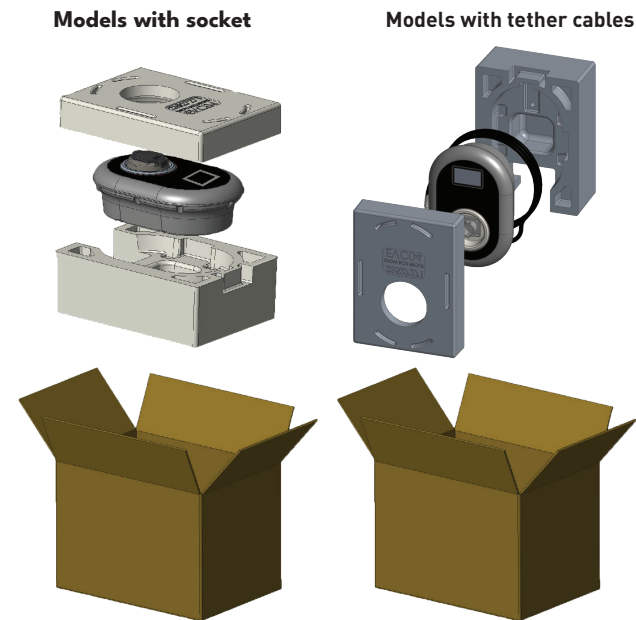











Figure-4

6.2 - SUPPLIED INSTALLATION EQUIPMENT and ACCESSORIES

Accessory/Material Name	Use for	Quantity	Image
Dowels (M8x50 Plastic Dowels)	Mounting the charging station to the wall	4	
Torx T25 security screw (M6x75)	Mounting the charging station to the wall	4	
Gasket for screw 6x75	IP for screws that are used for Mounting the charging station to the wall	4	
Torx T20 Security L-Wrench	IP for the screws that are used to mount the charging station to the wall.	1	
Wrench	Disassembling and fastening cable glands	1	
RCCB Wrench(Optional)	To open the RCCB cover	1	



RJ45 male connector - optional	LAN cable connection	1	
Mounting Template	Mounting the charging station to the wall	1	
O-Ring	Mounting the charging station on the mast	3	
Screw M6X20	Mounting the charging station on the mast	3	
Screw M6X30	Mount and provide earth continuity for the charger, which is mounted on a metal surface. This screw must be mounted in the hole at the bottom right of the charging station on the wall. Under this screw, there should be rubber to secure the earth cable.	1	
IP Rubber	Fasten the earth cable with the M6x30 screw. This rubber should be placed right-side-down The wall-mounting hole of the charging station, below the earth cable and the M6x30 screw	1	
SIM Card(Optional)	Product control with internet connection	1	
User RFID Card (Given with E7-W and E11-W variants)	Start&Stop Charging	2	
Master RFID Card (Given with E7-W and E11-W variants)	Adding&Removing the User RFID Cards to Local RFID List	1	
Installation Guide	Installation Manual	1 Set	
Instruction Book	User Manual	1 Set	

6.3 - PRODUCT INSTALLATION STEPS

CAUTION!

- Ensure that the ground resistance of the installation is less than 100 ohms.
- Prior to mounting your charging station on the wall, read these instructions.
- Do not mount your charging station to the ceiling or an inclined wall.
- Use the wall mounting screws and other accessories specified.
- This charging station is classified as indoor and outdoor installation compatible. If the device is installed outside the building, the hardware that will be used to connect the cables to the charger shall be compatible with outdoor use and the charging station shall be mounted preserving the IP rate of the charger.

6.3.1 - OPENING THE COVER OF THE CHARGING STATION

	ATTENTION RISK OF ELECTRIC SHOCK	
Please power off the charging station mains supply 		

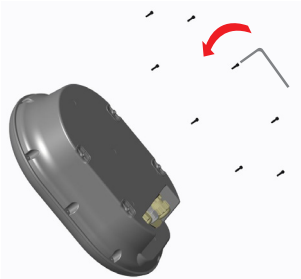
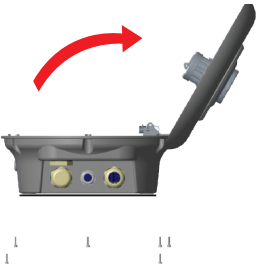
	
1	2
1- Remove the cover screws with Torx T20 security L-Wrench or Right Angle Screwdriver Adapter using Torx T20 Security Bit.	
2- Open the cover	

6.3.2 - WALL MOUNT INSTALLATION

Wall mount installation is common for all charging station models.

- 1- Open the product front cover by following the instruction.
- 2- Place the charging station to the Wall by using the mounting template which is given in accessory bag and mark the drill bit holes with a pencil.
- 3- Drill the wall on the marked points using the impact drill (8mm drill bit).
- 4- Place the dowels into the holes.
- 5- Tighten the security screws (6x75) of the product using Torx T25 Security Screwdriver.
- 6- Insert the AC mains cable into the charging station from the left cable gland which below the station. Follow the AC Mains Connection instructions on the next pages, depending on the model of the charger. (Single/Three Phase)
- 7- When mounting the charging station on conductive metal surfaces such as metal poles, etc., you can make the grounding connection via the “bottom right” screw using the grounding extension cable as shown in the figure below. To ensure grounding, you need to change the position of the ground wire from “a” to “b” as shown in the figure below. The figure below shows the ground connections for single phase and three phase. Follow the instructions below.
 - i. Insert the plastic support (IP rubber supplied in the unit’s accessory package) into the fixing hole (position “b”)
 - ii. Secure the ground wire using the M6x30 screw included in the artwork package, which is also used to mount the product to the conductive metal surface.

Note: Both grounding and sealing are achieved by first putting a rubber gasket under the ground wire and then tightening the screw, respectively, as shown in the figure.
- 8- Tighten the cable glands as shown in the figure. Before closing the cover of the charging station, follow the instructions in next sections if any function related to these sections are used.
- 9- To close the cover of the charging station, tighten the cover screws which you were removed with Torx T20 Security L-Wrench or Right Angle Screwdriver Adapter using Torx T20 Security Bit.
- 10- Mounting the charging station on the wall is finished.

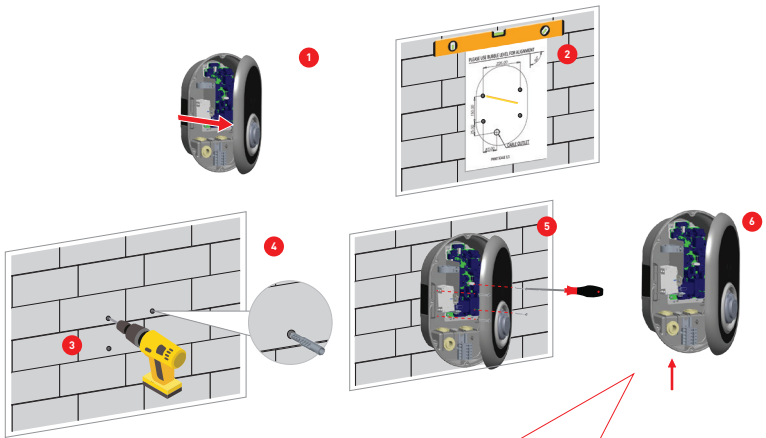

Before next step (7), Please check the instructions for Single Phase or Three Phase cable connections.

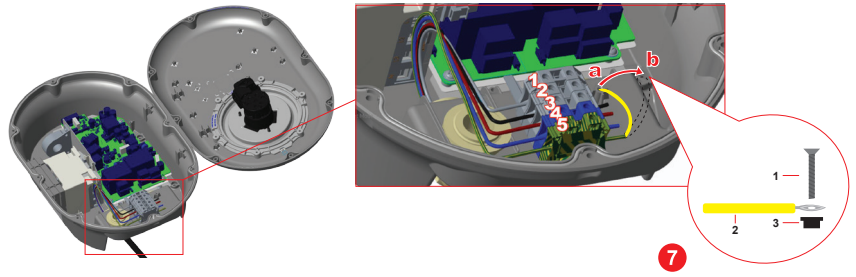
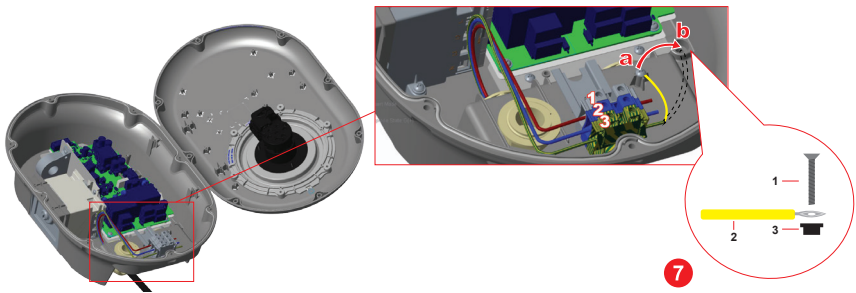

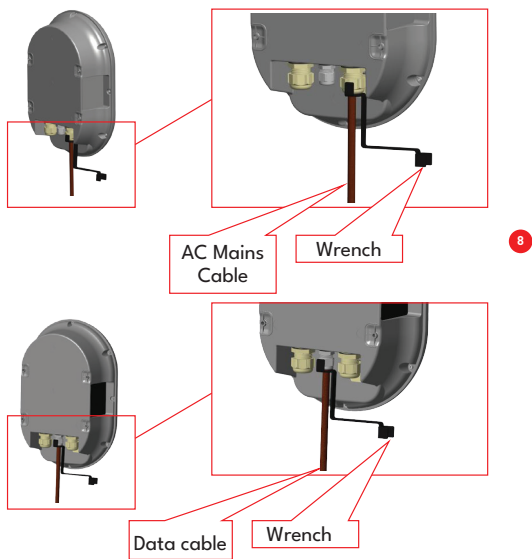

Before closing the cover of the charging station, check next instructions if any function related to these sections are used.

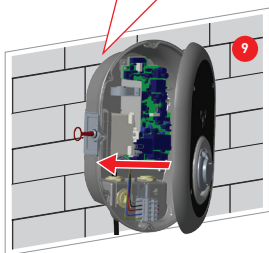

6.3.3- SINGLE PHASE CHARGING STATION AC MAINS CONNECTION

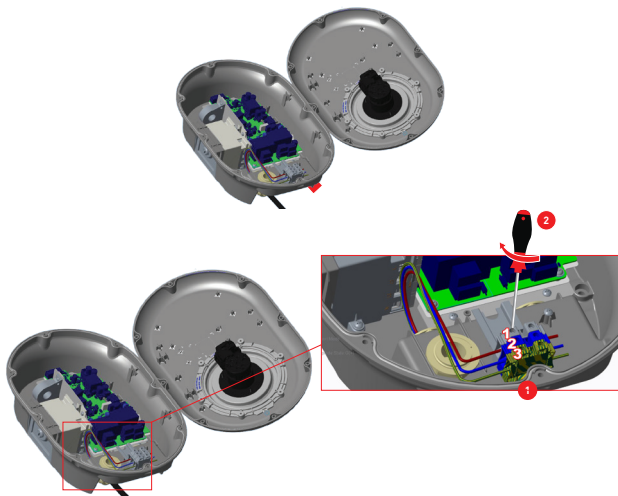

- 1- Insert the cables to the terminal block as shown in the image. Check the table below to match Electric Terminal number with AC Cable Color.
- 2- Tighten the screws on the terminal block as shown in the image with the tightening torque of 2.5Nm.

Electric Terminal	AC Cable Color
1	AC L1 (Brown)
2	AC Neutral (Blue)
3	Earth (Green-Yellow)

For single phase **IT Grid** installation, wiring diagram which is shown below should be used. Also grounding type should be set to "IT Grid" from the "Installation settings" menu in web user interface.

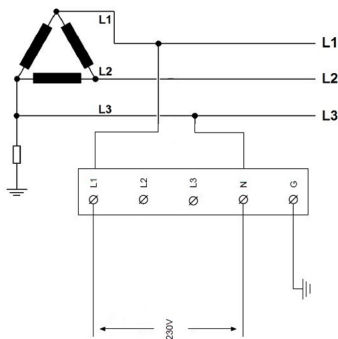

6.3.4- THREE PHASE CHARGING STATION AC MAINS CONNECTION

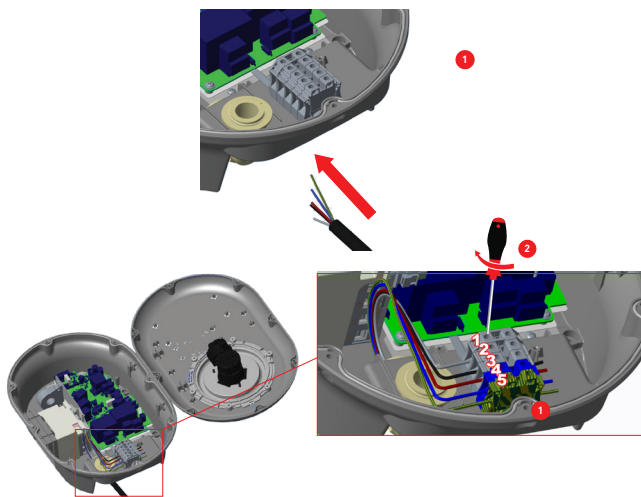

- 1- Insert the cables to the terminal block as shown in the image. Check the table below to match Electric Terminal number with AC Cable Color.
- 2- Tighten the screws on the terminal block as shown in the image with the tightening torque of 2.5Nm.

Electric Terminal	AC Cable Color
1	AC L3 (Grey)
2	AC L2 (Black)
3	AC L1 (Brown)
4	AC Neutral (Blue)
5	Earth (Green-Yellow)

If the three phase charging station is requested to be installed as single phase, phase cable connection should be done to L1 terminal as shown in figure.

6.3.5 - BROKEN PEN DETECTION FEATURE (Optional)

This feature is valid for single phase units and should only be used on single phase TN-C-S supplies. Protection against electric shock in the installation is provided by a contactor which electrically disconnects the vehicle from the live conductors of the supply, from protective earth and from control pilot within 5 seconds in the event of the supply voltage to the charging point, between the line and neutral conductors, being greater than 252 V rms or less than 207 V rms.

If the unit detects broken PEN, it automatically goes into error mode and can only be cleared by power cycling the charge point i.e. powering off and back on again. The unit should be reset to get over the error.

6.3.6 - ADJUSTING CURRENT LIMITER

The charging station has current limiter (rotary switch) on the mainboard which is shown in figure below. This switch is used for adjusting the current and power of charging station. The arrow in the middle of the rotary switch must be adjusted gently by rotating with a flathead screwdriver to the position of the required current rate. The details of the current rates are described in table below.

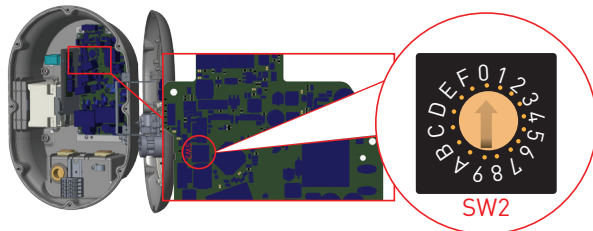

Current Limiter Position	Current Limit Value			
	Phase	22 kW	11kW	7.4kW
0	1-Phase	6 A	6 A	6 A
1		10 A	10 A	10 A
2		16 A	16 A	16 A
3		20 A		20 A
4		25 A		25 A
5		30 A		30 A
6		32 A		32 A
7				
8	3-Phase	6 A	6 A	
9		10 A	10 A	
A		16 A	16 A	
B		20 A		
C		25 A		
D		30 A		
E		32 A		
F				

Table-7

Required Circuit Braker on AC Mains	
EV Charging Station Current Limiter Setting	C-Curve MCB
10 A	13 A
13 A	16 A
16 A	20 A
20 A	25 A
25 A	32 A
30 A	40 A
32 A	40 A

Table-8

6.3.7 - DIP SWITCH SETTINGS

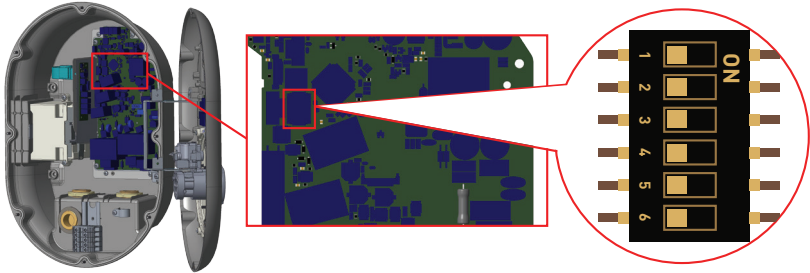

Brief descriptions of the DIP switch pin settings can be found in below table.

Pin Number	Description
Pin-1	Reserved
Pin-2	External Enable Input Functionality
Pin-3	Locked Cable Function (only for socket models)
Pin-4-5-6	Power Optimizer (Requires Optional Accessories)

6.3.7.1 - DATA CABLE CONNECTION

- 1- Remove rubber cork from cable gland.
- 2- Insert cable through the cable holes.
- 3- Insert the cable through the RCCB housing holes.
- 4- Finally, to connect the wires on mainboard, check next sections depending on the functions to be used.

NOTE : Below data connection cables can be inserted through the cable holes;

- a. External enable input cable
- b. Power optimizer measurement cable
- c. Ethernet daisy chain connection cables (Optional)
- d. Load shedding triggering signal cable
- e. Shunt trip module control signal cable for welded relay contact failure

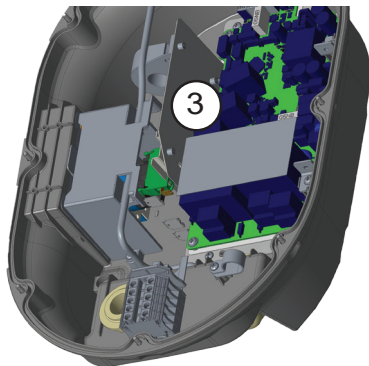
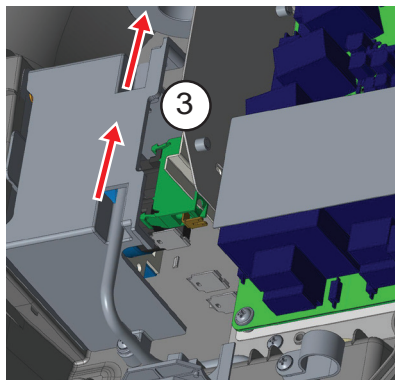
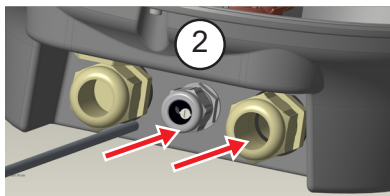
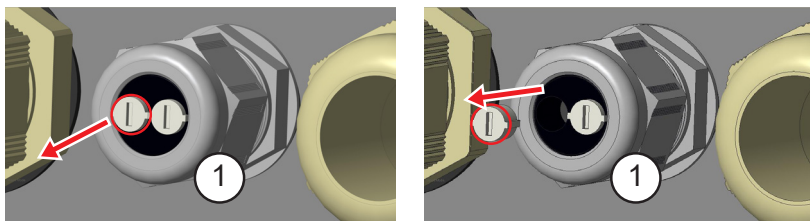

6.3.7.2 - EXTERNAL ENABLE INPUT FUNCTIONALITY

Your charging station has external potential free enable / disable functionality which can be used for integration of your charging station to an carpark automation systems, energy supplier ripple control devices, time switches, photovoltaic inverters, auxiliary load control switches, external key lock switches etc. DIP switch position 2 is used for enabling and disabling this functionality.

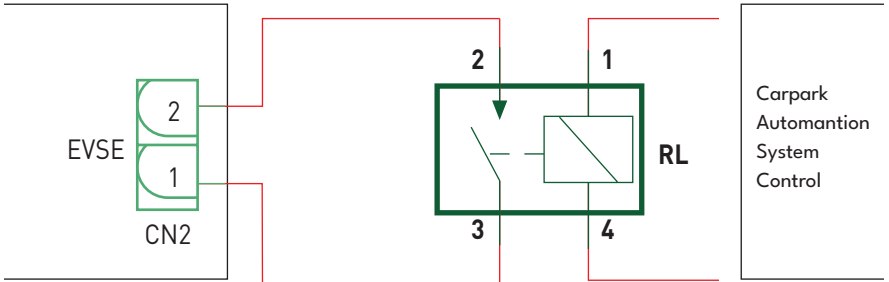
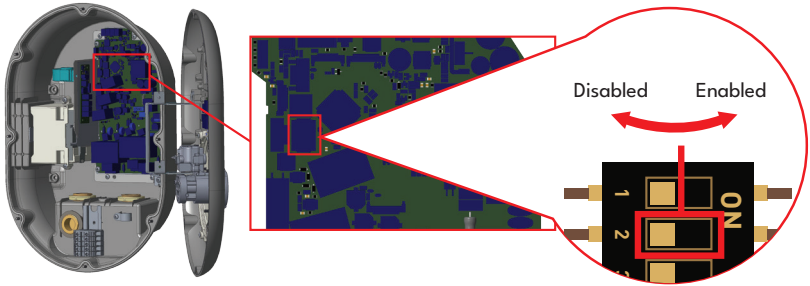

If the external relay (RL) is in non-conducting (open), the charging station will not be able to charge the electric vehicle.

You can connect potential free input signals as shown in above circuitry (see figure).

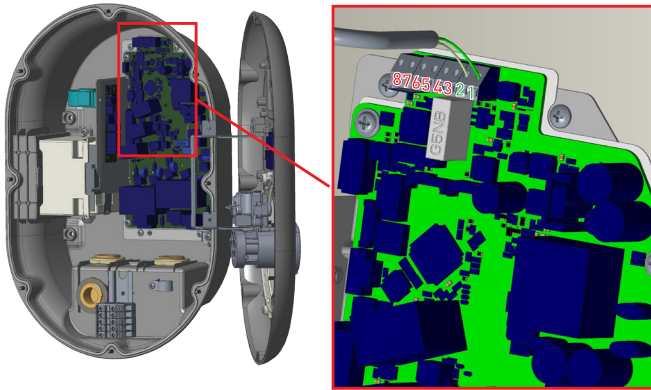

Cable Terminal	Cable Color
1 (CN2-1)	Green
2 (CN2-2)	Green + White Green

6.3.7.3 - LOCKED CABLE FUNCTION (Model With Socket)

This charging station has functionality for fixing the charging cable of the user, to the charging socket of the unit. The cable becomes locked and socket model charging station behaves as a cabled model. For this functionality, the steps in table can be followed.

1- Turn off the power of your charging station.



2- Open the product cover as described in the installation manual.

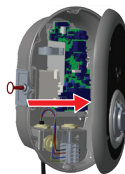

3- To enable locked cable function, toggle DIP switch pin 3 to ON position using pointed spudger or a plastic pointed tool. The DIP switch location is as shown in below figure.

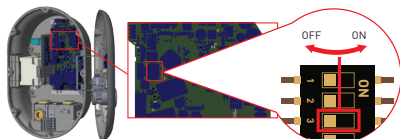

4- Close the product cover as described in the installation manual.

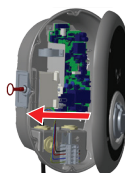

5- Open the front cover of the socket outlet and plug the charging cable to the socket outlet.

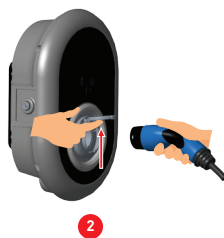

6- Turn on the power to your charging station. The cable becomes locked and the charging station starts behaving as a cable model.



6.3.7.4 - POWER OPTIMIZER (REQUIRES OPTIONAL ACCESSORIES)

The EV charger has option to make single load balancing with different accessories.

1. Power Optimizer with External MID meter
2. Power Optimizer with External Current Transformer (CT)

To adjust the power optimizer, the slide switch (mode selection switch - SW3) on the control board should be in position to 1 or 2 as shown in figure. If the switch is set to position 3, power optimizer does not work.

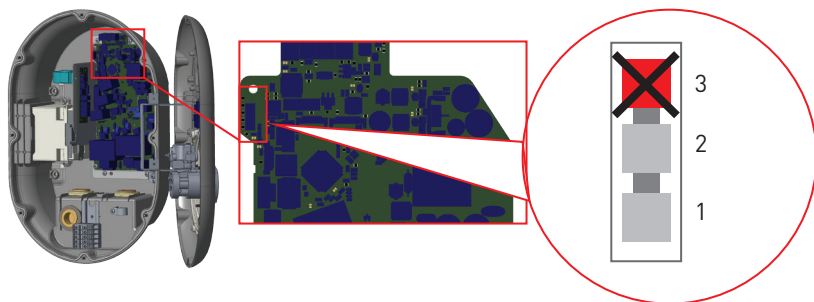

This feature is provided with an optional metering accessories which are sold separately. In power optimizer mode, the total current drawn from the main switch of the house by charging station and other household appliances is measured with current sensor integrated to the main power line. Current limit of the main power line of the system is set through the DIP switches inside the charging station. According to the limit set by the user, charging station adjusts its output charging current dynamically according to the measurement of main power line.

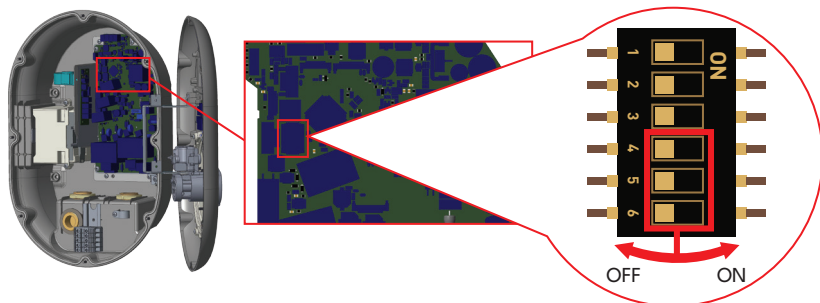

Last 3 DIP switch pins (4,5,6) shown in figure below corresponds to binary digits of the maximum current value as shown in the table. When 4, 5, 6 pins are in OFF position, power optimizer functionality is disabled.

DIP Switch Positions			Current Limit Value
4	5	6	
OFF	OFF	OFF	Power Optimizer Disabled
OFF	OFF	ON	16
OFF	ON	OFF	20
OFF	ON	ON	25
ON	OFF	OFF	32
ON	OFF	ON	40
ON	ON	OFF	63
ON	ON	ON	80

6.3.7.4.1 - Power optimizer with external MID meter

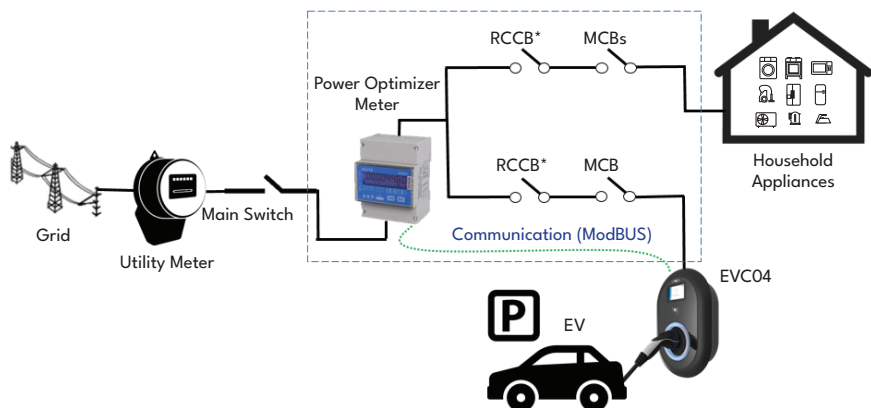

*This figures valid for variants which do not have integrated RCCB. If the charging station has integrated RCCB, there is no need to add additional RCCB in power line.

Power Optimizer Meter should be placed just after the main switch of the house as shown in the figure. Power Optimizer Meter wiring connections can be made according to the information below.

Three Phase

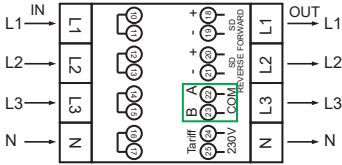

Single Phase

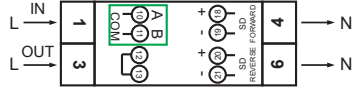

■ 22-23: A-B (COM) Modbus connection over RS485 for three phase charging station models.

■ 10-11: A-B (COM) Modbus connection over RS485 for single phase charging station models.

Related board wiring of Power Optimizer connections can be made as shown below:

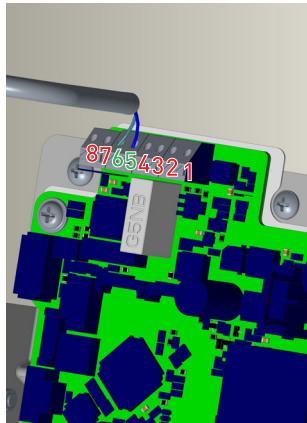
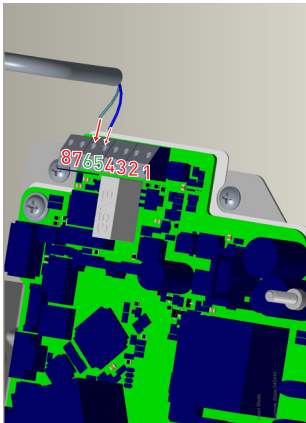

Cable Terminal	Cable Color	Description
6 (CN20-2)	White Blue	A (COM)
5 (CN20-1)	Blue	B (COM)

6.3.7.4.2 - POWER OPTIMIZER WITH EXTERNAL CURRENT TRANSFORMER (CT) (Optional)

This function is provided with an optional external current measurement accessory, which is sold separately. In power optimizer mode, the total current drawn from the main house switch by the charging station and other home appliances is measured by a current sensor built into the main power line. The system main power line current limit is set by the DIP switches inside the charging station. Based on the limit set by the user, the charging station dynamically adjusts its output charging current based on the measurement of the main power line.

To perform the corresponding installation, follow the steps below.

The slide switch (SW3) on the control board shown in Figure below should be set to 1 or 2.

The wiring of the external electrical circuits and the “Integrated TIC Receiver / Power Optimization Module” inside the EV charger should be done as shown in Figure below. (For more information on using the “Integrated TIC Receiver / Power Optimization Module”.

The DIP switch on “The Integrated TIC Receiver / Power Optimization Module” should be set as shown in the table in Figure below.

The DIP switch on the control board should be set as shown in figure below and table below.

CAT5 cable length < 100m

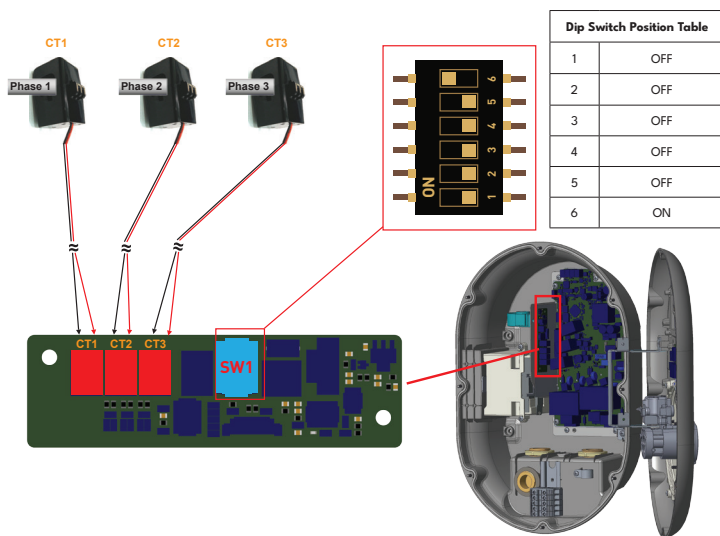

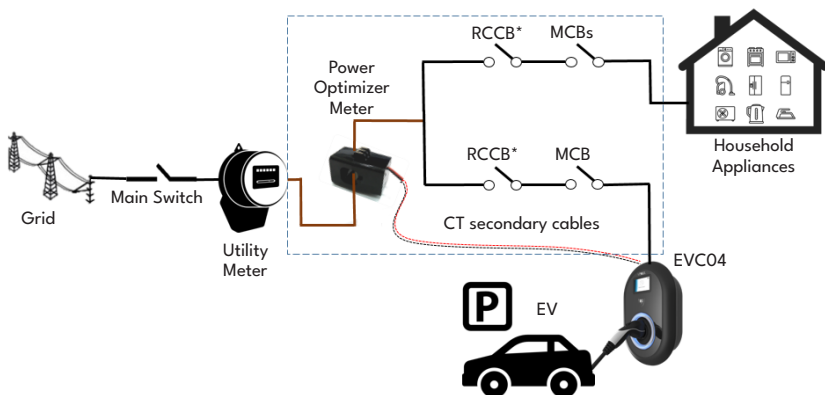

*This figure is valid for variants that do not have an integrated RCCB. If the charging station has an integrated RCCB, there is no need to add an additional RCCB in the power line. The power optimizer with external CT should be placed as shown in the figure below.

6.3.8 - MODE SELECTION SWITCH SETTINGS

This charging station has 3 operation modes. For standard charging the mode selection should be in position 1.

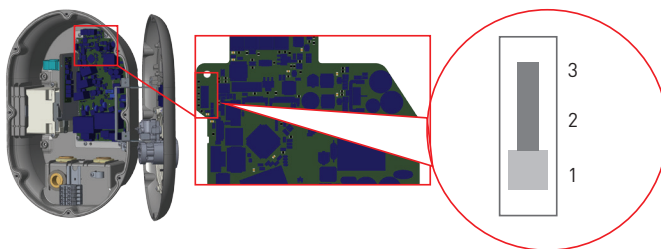

1. **Operation Mode 1 (Standard Charging):** This mode is factory default configuration. When this mode is selected, charging station does not support peak/off peak time or TIC dynamic charging scenarios.
2. **Operation Mode 2 (Postponed Charging):** For this mode, slide switch should be positioned as 2. When this mode is selected, charging station supports “C1-C2 Peak/Off Peak Time” signaling input and reacts accordingly for peak/off peak time charging.
3. **Operation Mode 3 (TIC Dynamic Charging):** When this mode is selected, charging station supports receiving TIC (Tele Information Client) I1-I2 signal and reacts accordingly for peak/off peak time charging and regulates its charging power for dynamic load management according to the information sent by the meter via TIC signal.

6.3.9 - LOAD SHEDDING

This charging station supports load shedding functionality which provides immediate charging current reduction in case of limited supply. Load shedding functionality can be used in any mode including Standalone and OCPP connected modes. Load shedding triggering signal is a dry contact signal which must be provided externally and connected to the terminals 3 and 4 on the power board as shown in figure below.

When load shedding is activated by closing the contacts with an external device (Eg. ripple control receivers etc.) charging current reduces down to 8A. When load shedding is deactivated by opening the contacts charging continues with maximum available current. In normal use case when there is no signal connected to the load shedding input (contacts open between terminal 3 and 4) charging station supplies maximum available current.

You can connect dry contact (potential free) load shedding signal as shown in below. See figure below,table below.

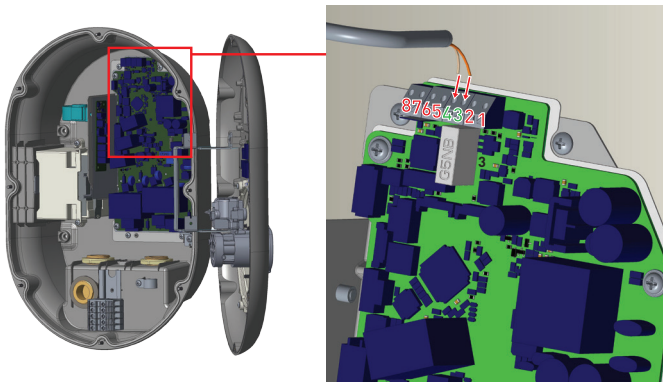

Cable Terminal	Input
3	Load Shedding Input +
4	Load shedding Input -

Load Shedding Input State	Behaviour
Opened Contact	Charge with max. available current
Closed Contact	Charge with 8A

6.3.10 - MONITORING OF WELDED RELAY CONTACTS FAILURE

According to IEC 61851-1 and EV/ZE Ready requirements, EVC04 EV Charging Station has welded contactor sensing function and in case of welded contact occurs, shunt trip 230V signal is provided from the main board. To detect welded contact failure for the relays, CN33 connector output terminals must be used.

In case of a welded contact for the relays CN33 connector output will be 230V AC. The output which has 230V AC should be connected to a shunt trip for RCCB triggering as shown in figure. The cabling should be done as shown in figure.

Connector (CN33) terminals must be connected to a shunt trip module. Shunt Trip module is mechanically coupled to RCCB (or MCB) at the fuse box of the charging station.

The circuitry block diagram that must be used at the fuse box of the charging station is shown below.

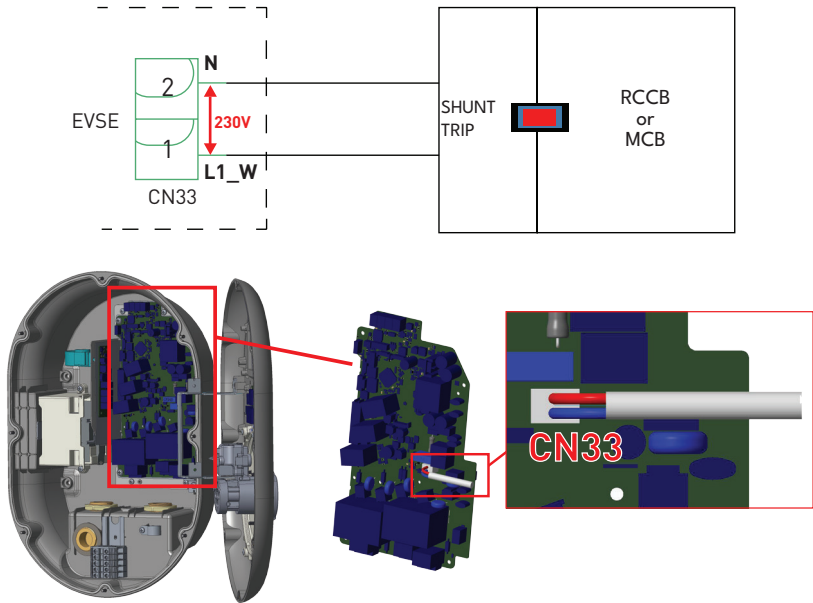

6.3.11 - FACTORY RESET

You must push the button on HMI board shown in figure below for factory reset. When you hold the button for 5 seconds user configuration will be reset to factory configuration. (e.g OCPP config, Network Config will be back to factory configuration.)

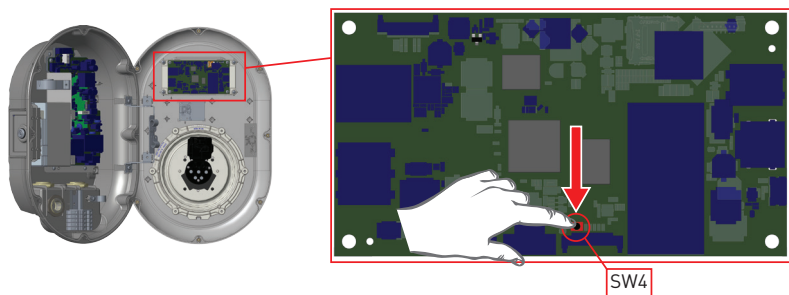

6.3.12 - RESETTING LOCAL RFID CARD LIST AND REGISTERING NEW MASTER RFID CARD IN STANDALONE USAGE MODE

If you lose your master RFID card and need to define a new master RFID card, below steps should be followed by your authorised service technician.

- Make sure the charging station is powered-off and open the front cover of your charger which is mentioned in installation guideline.
- Toggle the first position of DIP switch which is on the smart board of the charger shown in figure below. After that please turn on the charger again.

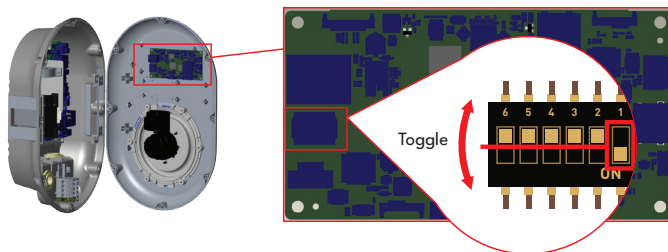

When the charger is powered on again please note that;

- Previously stored master card and user card list, if any exists, are deleted from charging station while entering the configuration mode. In configuration mode, the charger indication LED blinks red.
- If master card had not been registered during 60 seconds then configuration mode expires and charging station behaves as autostart product.
- The first RFID card which is registered within this 60 seconds of duration will be the new master RFID card. Please follow instructions to register RFID user card which is used during charging process.

6.3.13 - SETTING ETHERNET PORT OF CHARGER TO STATIC IP IN STANDALONE USAGE MODE

The charging station is preconfigured to DHCP mode in factory. If you need to connect to the charging station's web configuration interface directly using a computer, rather than using a router having DHCP server, steps below should be followed:

- Make sure the charging station is powered-off and open the front cover of your charger which is mentioned in installation guideline.
- Toggle the second position of DIP switch which is on the smart board of the charger shown in figure below. After that please turn on the charger again.
- Charging station sets the Ethernet port to 192.168.0.10 address statically and subnet mask will be set to 255.255.255.0

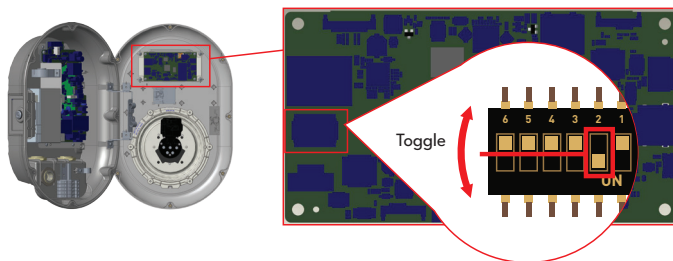

If the charger's LAN interface is needed to be set back to DHCP mode again this can be done from the web configuration interface.

Note: You can also use factory reset function to set the LAN interface back to DHCP mode again but please well note that all other parameters will be set to factory default parameters.

6.3.14 - WEB CONFIGURATION INTERFACE ENABLE / DISABLE

If you need to enable/disable the Web Configuration interface below steps should be followed:

- Make sure the charging station is powered-off and open the front cover of your charger which is mentioned in installation guideline.
- If you want to enable the web configuration interface, third position of DIP switch should be in "OFF" position as shown in figure below.
- If you want to disable the web configuration interface, third position of DIP switch should be in "ON" position as shown in figure below.

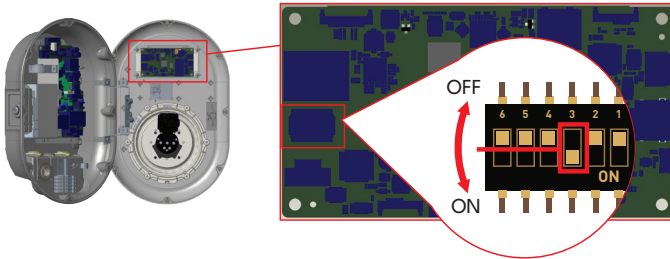

6.3.15 - ETHERNET DAISY-CHAIN CONNECTION (OPTIONAL)

Daisy-Chain is a wiring method of the devices in a network. It gives an opportunity to add/remove devices to/from network very easily. In order to make Daisy-Chain connection, an Ethernet hub board is used in EV Charger system. Basically it distributes all the Ethernet connection among the devices. Ethernet line cable coming from a device, a router or a hub needs to be connected to other device Daisy-Chain input port (CN5) as shown in Figure. Here, HMI Ethernet connection is made over CN6 port (Daisy-Chain HMI Out), and Daisy-Chain out connection is made over CN4. Internal Ethernet connection (Between HMI and Ethernet Hub Board) has been made during the production stage. So all is needed to make the connections of Daisy-Chain Input port and the Daisy-Chain Output port.

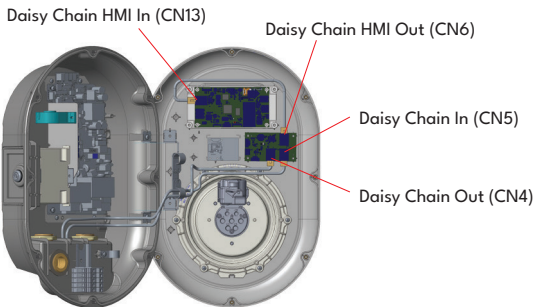

EV Charger Internal Ethernet Daisy Chain Cable Connections

Daisy chain connection can be used to share internet access between the devices. For internet access sharing, a Daisy-Chain connection can be done as shown in Figure. Here, Ethernet router/switch/hub is used to route the traffic in the medium and any device can communicate with the back-end server

directly. Remote PC can be used to reach out “Web Config UI” of each device in the network without any need to make a direct connection to the devices.

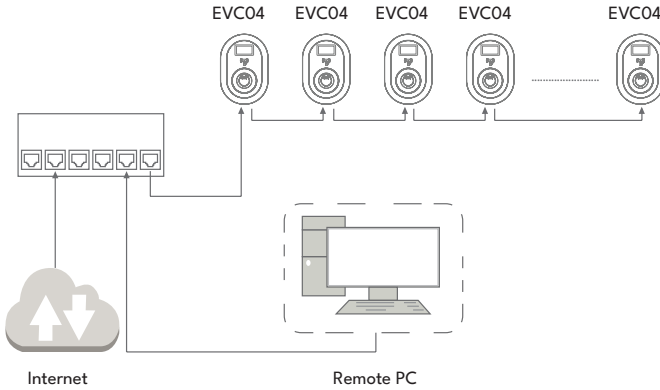

Daisy-Chain Connection based on Linear Topology

In linear topology, since devices are connected to each other in series, if one of them is switched off or has a power outage, the remained devices which are getting main network connection from this device will loss the connection with other devices. Thus, there will be two subnetworks if one of the devices has a connection problem.

6.4 - OCPP CONNECTION

Make sure the charging station is powered-off.

6.4.1 - CONNECT OCPP OVER CELLULAR NETWORK (Optional)

Insert the micro SIM card in the SIM card slot on cellular module as shown in the below figure.

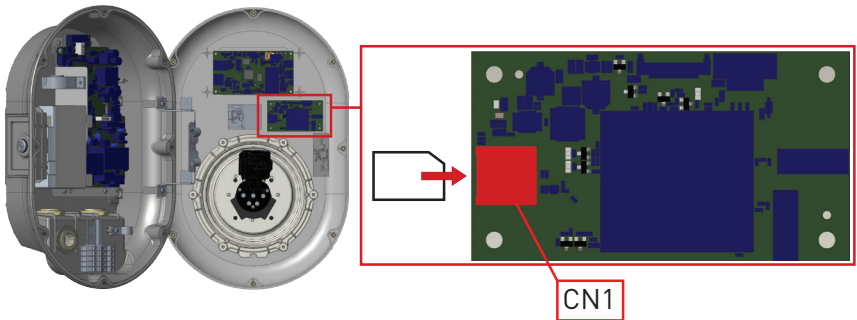

6.4.2 - CONNECT OCPP OVER ETHERNET

1- Insert cable through the cable gland.

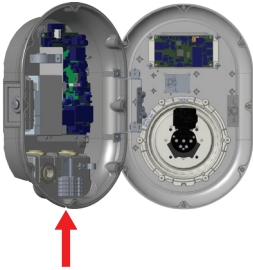

2- Pull the cable through the cable clamps as indicated by arrows in below figure.

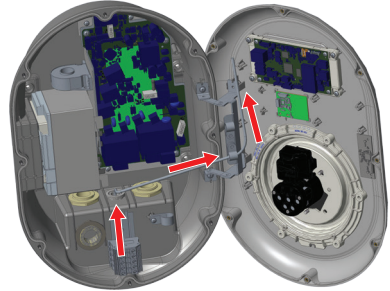

3- Using a Crimping Tool, trim the end of the cable you're terminating, to ensure that the ends of the conducting wires are even.



4- Strip off approximately 1 inch of the cable's jacket, using a modular crimping tool or a UTP cable stripper.



5- Separate the 4 twisted wire pairs from each other, and then unwind each pair, so that you end up with 8 individual wires.



6- Moving from left to right, arrange the wires in a flat, side-by-side ribbon formation, placing them in the following order: white/orange, solid orange, white/green, solid blue, white/blue, solid green, white/brown, solid brown.



7- Carefully insert the flattened, arranged wires into the connector, pushing through until the wire ends emerge from the pins.



8- Check to make sure that the wire ends coming out of the connector's pin side are in the correct order. If you realize that a mistake has been made in wire order after termination, you'll have to cut the connector off and start all over again!

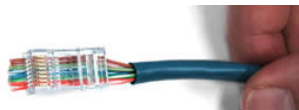

9- Insert the prepared connector/cable assembly into the RJ45 slot in your crimping tool. Firmly squeeze the crimper's handles together until you can't go any further. Release the handles and repeat this step to ensure a proper crimp.



10- If your crimper doesn't automatically trim the wire ends upon termination, carefully cut wire ends to make them as flush with the connector's surface as possible. The closer the wire ends are trimmed, the better your final plug-in connection will be.



11- Termination is complete.

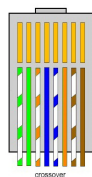
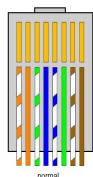

12- Insert the RJ45 connector to the socket as shown in figure below.

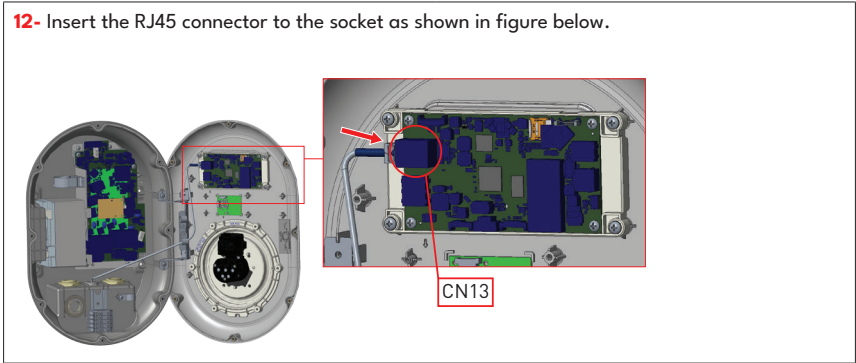

6.5 - COMMISSIONING

If you want to connect the charging station's web configuration interface, you have two options;

a. You can directly connect your PC to the charging station using a patch Ethernet cable. If you follow this option, please make sure that you have properly configured your charging station's LAN interface to static IP by following steps in section "SETTING ETHERNET PORT OF CHARGER TO STATIC IP IN STANDALONE USAGE MODE" and your charging station's web configuration interface is enabled via DIP switch which is mentioned in section "WEB CONFIGURATION INTERFACE ENABLE / DISABLE". By default, web configuration interface is enabled.

b. You can use a router having DHCP server. In this option, both the charging station and the PC should be connected to the router. Please be sure that you need to check the IP address from the router to be able to make the connection.

For direct PC connection option, you need to connect your PC to the charging station to use functions and make configurations below:

- Login
- Change Password
- Main Page
- General Settings : Display Language, Display Backlight Settings, Led Dimming Settings, Standby Led Behaviour, Display Service Contact Info, Logo Settings, Display QR Code, Scheduled Charging
- Installation Settings : Earthing System, Current Limiter Settings, Unbalanced Load Detection, External Enable Input, Lockable Cable, Charging Mode Selection and Power Optimizer Configuration-Location -Load Shedding Minimum Current.
- OCPP Settings : OCPP Connection, OCPP Version, Connection Settings, OCPP Configuration Parameters
- Network Interface Settings : Cellular, Ethernet, Wi-Fi, Wi-Fi Hotspot
- Standalone mode settings
- Local Load Management : General Settings
- System Maintenance: Log Files, Firmware Updates, Configuration BackUp&Restore, System Reset, Administration Password, Factory Default Configuration

6.5.1 - CONNECT PC TO THE SAME NETWORK WITH SMART BOARD

In order to access web configuration interface, first you need to connect your PC and EV charger to the same ethernet switch or connect EV charger to your PC directly.

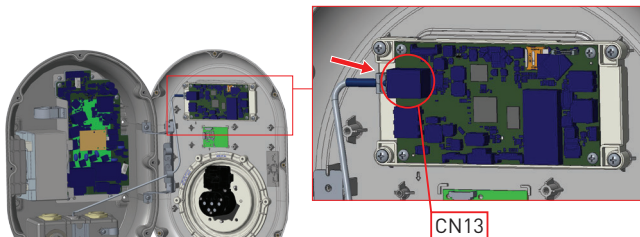

Default IP address of HMI board is 192.168.0.10. For this reason, you need to give static IP to your PC in the same network with HMI board.

You should assign static IP address to your PC in 192.168.0.254 network which means that IP address should be in a range of between 192.168.0.1 and 192.168.0.254.

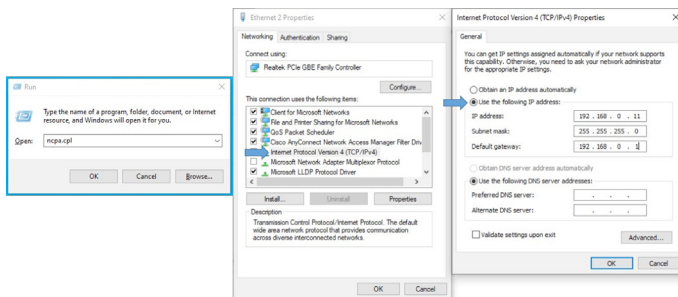

6.5.2 - OPENING WEB CONFIGURATION INTERFACE WITH BROWSER

Open your web browser and type 192.168.0.10 which is IP address of smart board.

You will see login page on your browser;

When you want to enter to the web configuration interface in the first time, you will see the warning as “We recommend you to change your default password from system maintenance menu”.

You can enter the system with:

Default username = admin

Default password = admin

You can change password with Change Password Button in login page or Administration Password section in the System Maintenance tab.

Attention: For web configuration interface accessibility problems; Web browsers usually save some information from websites in its cache and cookies. Forcing Refresh or Clearing (depending on your operating system and browser) them fixes certain problems, like loading or formatting issues on web page.

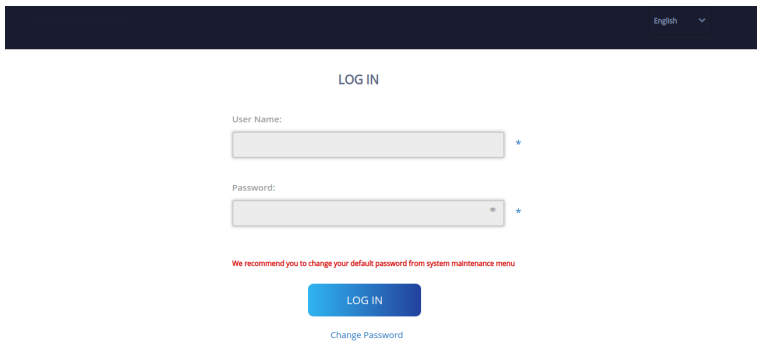

If you click the “Change Password Button” you will be redirected to the Change Password page. New password must contain at least 1 lowercase letter, 1 uppercase letter, 1 numeric character and minimum 6 characters.

After typing your current password and new password twice, you will be redirected to the login page again to log in with your new password.

All spaces you will see are mandatory in this page.

After submitting this page you will be redirected to login page. Also if you don't want to change the password you can turn back the login page with “Back To Login”. Changing password is important for your security.

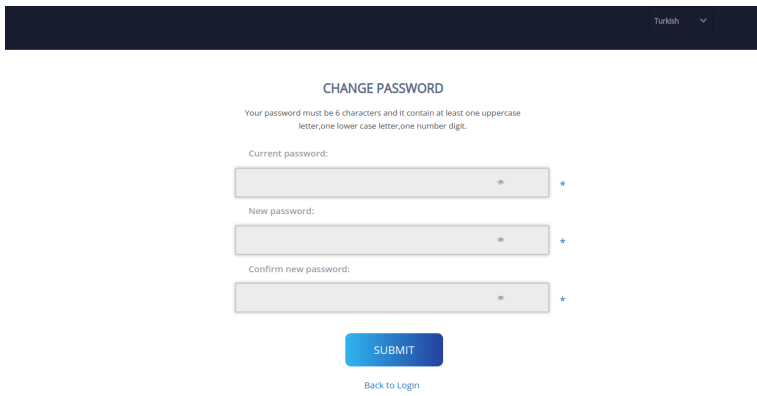

6.5.3 - OPENING THE WEB CONFIGURATION INTERFACE VIA WIFI HOTSPOT

All EVCO4-Models have a WiFi hotspot feature which is enabled by default. (The charging station should have firmware version v2.65.0 (or higher). The units which have older firmware version should be updated to have WiFi hotspot feature.) For configuration of the charging station over configuration web interface, WiFi hotspot is activated during every power on cycle of the charging station for 15 minutes or whichever time is set by the user in network settings. During this time slot it is possible to connect a device (mobile, tablet or a notebook) with the charging station. The credentials for the access is standardly the SSID (serial number) and the Chargebox-ID as the password. You can find both information on the cartonage and on the type plate of the unit.

After connecting “Wi-Fi Hotspot” network, user can open web browser from computer or mobile device and type 192.168.1.1 which is IP address of the charging station. During Wi-Fi Hotspot active period, it may not be possible for the charging station to connect to a remote back end system. Charging station will reconnect after the Wi-Fi Hotspot active period expires.

For Android mobile devices, it is needed to configure-the browser to download and show desktop site from the menu at the upper right corner in Google Chrome browser.

For IOS mobile devices, it is needed to configure-the browser to download and show desktop site from the menu at the upper right corner and also the text size should be set to 50% from the AA setting at the upper left corner in Safari browser.

After entering the credentials for the connection the user will see login page of web configuration interface in browser as below.

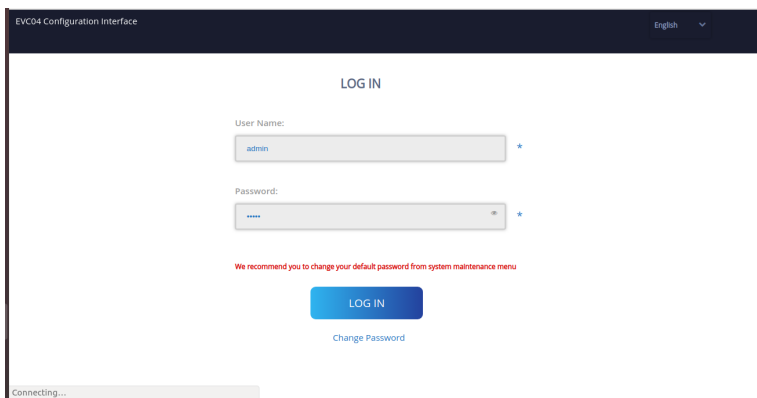

The user name and password information to access the web configuration interface are as follows.

User name: admin

Password: admin

Note: The maximum number of users that can connect to the WEB configuration interface via Wi-Fi hotspot is 3. Supports 2.4 Ghz.

6.6 - PRODUCT VARIANTS

There are two main product variants which differ in their Pre-Sets.

6.6.1 - Default Setting “Standalone”

	LTE capable	SIM Card Integrated	WiFi	Display	Ethernet	MID Meter Integrated	ISO1518 prepared (PLC HLC)	Type2 AC Socket	Attached Cable	RCCB TypeA	DC6 mA Sensor	RFID Cards Attached	Broken PEN Detection	Current Transformer	Smart Charging
EVC04-E7-W-S			x		x			x			x	x			
EVC04-E7-W-C			x		x				5m		x	x			
EVC04-E7-WCTPEN-C			x		x				5m		x	x	x	x	
EVC04-E7-WCTPEN-S			x		x			x			x	x	x	x	
EVC04-E7-WCTSCPEN-S			x		x			x			x	x	x	x	x
EVC04-E7-WCTSCPEN-C			x		x				5m		x	x	x	x	x
EVC04-E11-W-S			x		x			x			x	x			
EVC04-E11-W-C			x		x				5m		x	x			
EVC04-E22-WLDM-S(R)	x	x	x	x	x	x		x			x	x			
EVC04-E22-WLDM-C(R)	x	x	x	x	x	x			7m		x	x			

Default factory preset is “Standalone”. Preset availability and selections are shown in figure below for Standalone product family.

Pre-set automatically selected : Standalone

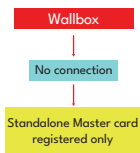

Pre-sets which can be manually selected

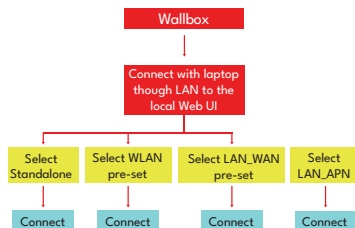

6.6.2 - Default Setting “E.ON Auto-Detect”

The product models and general features are as shown in table below:

	LTE capable	SIM Card Integrated	WiFi	Display	Ethernet	MID Meter ntegrated	ISO15118 prepared (PLC HLC)	Type2 AC Socket	Attached Cable	RCCB TypeA	DC6 mA Sensor	RFID Cards Attached	Broken PEN Detection	Current Transformer	Smart Charging
EVC04-E11-WDM-S			x	x	x	x		x			x				
EVC04-E11-WDM-C			x	x	x	x			5m		x				
EVC04-E22-WLDM-S	x	x	x	x	x	x		x			x				
EVC04-E22-WLDM-C	x	x	x	x	x	x			7m		x				
EVC04-E22-WLPDM-S	x	x	x	x	x	x	x	x			x				
EVC04-E22-WLPDM-C	x	x	x	x	x	x	x		7m		x				
EVC04-E22-WLDSCM-S	x	x	x	x	x	x		x			x				x
EVC04-E22-WLDSCM-C	x	x	x	x	x	x			7m		x				x

Default factory preset is “E.ON Auto-Detect”. Preset availability and selections are shown in figure below for E.ON Auto-Detect product family.

Pre-set automatically selected : E.ON Auto-Detect

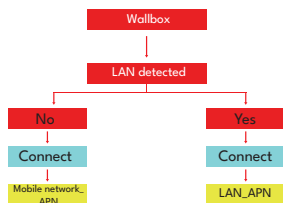

Pre-sets which can be manually selected

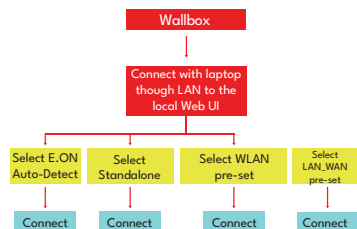

6.7 - WEB CONFIGURATION INTERFACE

6.7.1 - MAIN PAGE

After you logged in successfully, you are directed to the main page.

Main page shows the general information about the device such as software versions, connection interface and IDs.

You can also change the web configuration interface language and log out of the web configuration interface with the buttons in the upper right corner of the page.

The following languages are available: Turkish, English, German, French, Romanian, Spanish, Italian, Finnish, Norwegian, Swedish, Hebrew, Danish, Czech, Polish, Hungarian, Slovakian, Dutch. The boxes are configured in English by default.

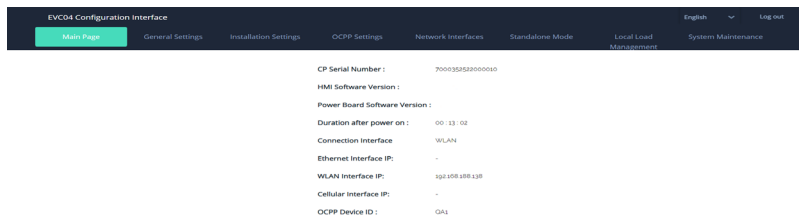

6.7.2 - CHANGE GENERAL SETTINGS OF THE DEVICE

6.7.2.1 - Display Language

Technician can select display language from the general settings page. Available languages for display language are as shown in figure below for now. After selecting the language, user can save selection by "Save Button".

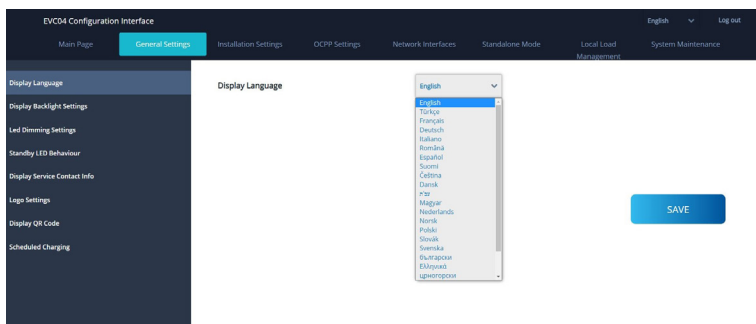

6.6.2.2 - Display Backlight Settings

Technician can adjust the brightness level of display by selecting the desired option in drop down menu. If technician selects backlight level as “Time Based”, Sunrise and Sunset Time selections are shown and can be configured. “Sunrise Time” defines the transition time of low to high backlight level. Similar, “Sunset Time” defines the transition time of high to low backlight level. Sunrise and sunset time based configuration is periodic daily setting.

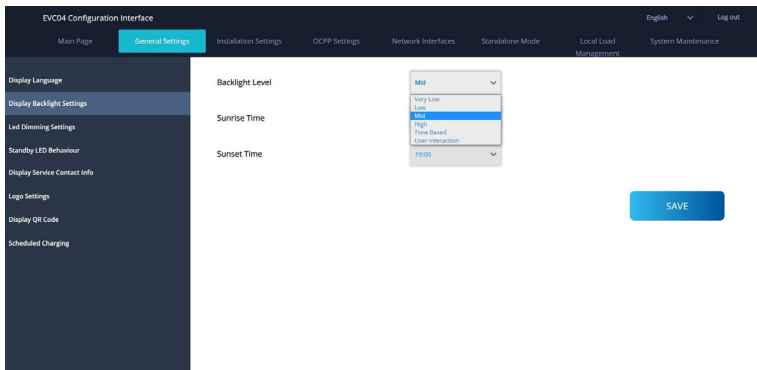

6.6.2.3 - Led Dimming Settings

Technician can adjust the brightness level of Led ring by selecting the desired option in drop down menu. If technician selects Led dimming level as “Time Based”, Sunrise and Sunset Time selections are shown and can be configured. “Sunrise Time” defines the transition time of low to high backlight level. Similar, “Sunset Time” defines the transition time of high to low backlight level. Sunrise and sunset time based configuration is periodic daily setting.

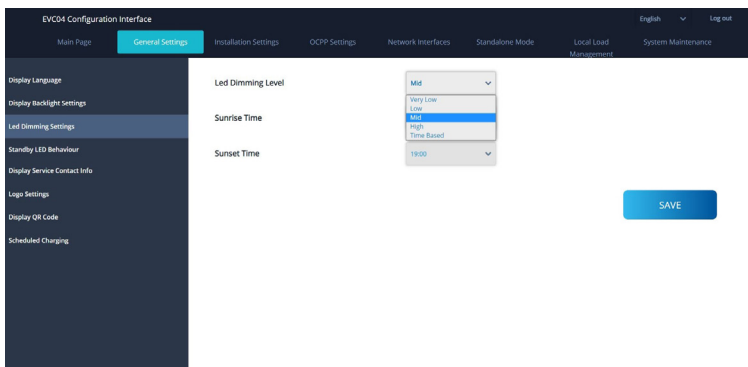

6.6.2.4 - Standby Led Behaviour

You can select HMI standby LED behaviour from the general settings page. Standby LED Behaviour can be on or off.

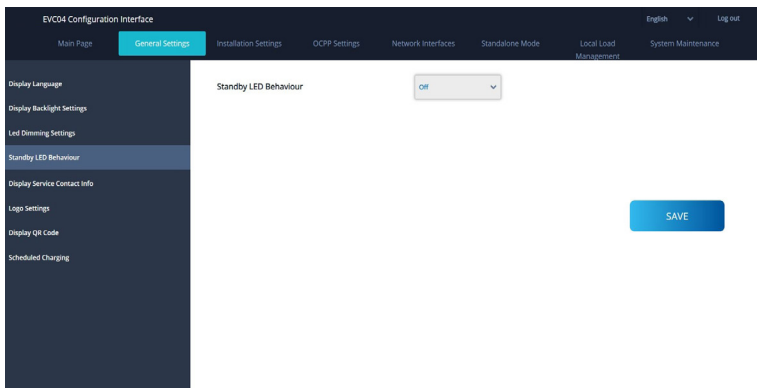

6.6.2.5 - Display Service Contact Info

Technician can enter the requested contact info of the service from this menu to be able to shown in display.

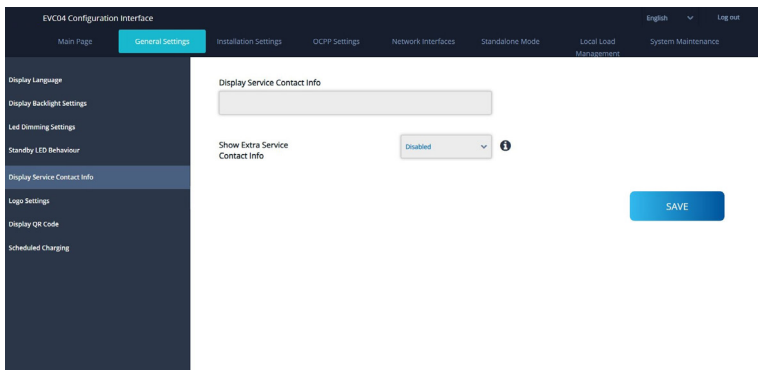

6.6.2.6 - Logo Settings

Technician can change the display logo of the station from the logo settings by uploading the required logo. The new logo should be in 80x80 pixels and .png format.

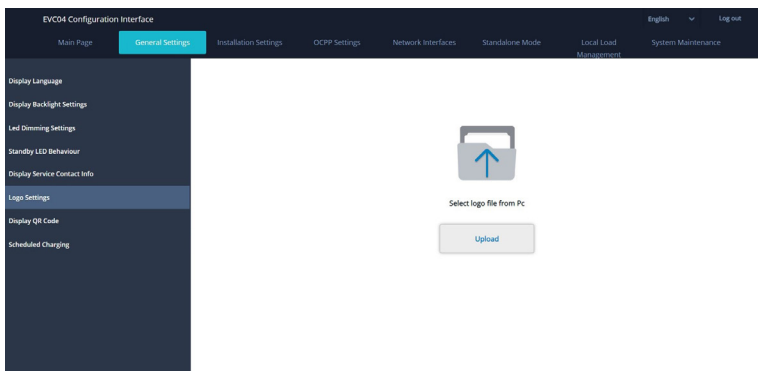

6.6.2.7 - Display QR Code

You can upload or remove QR code from the general settings page.

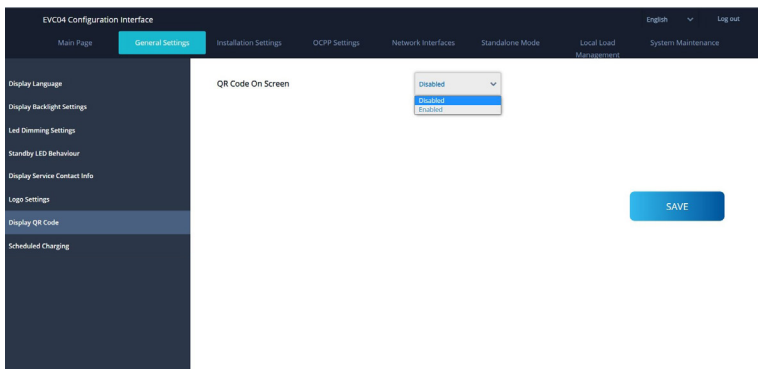

6.7.2.8 - Scheduled Charging

Off-peak charging function will be active if and only if device is connected to the central system. For the unit in standalone mode the settings will be as above. For Standalone modes, off peak charging will be hidden because of the time sync issue. Randomised Delay Maximum Duration, can take values between 0 and 1800.

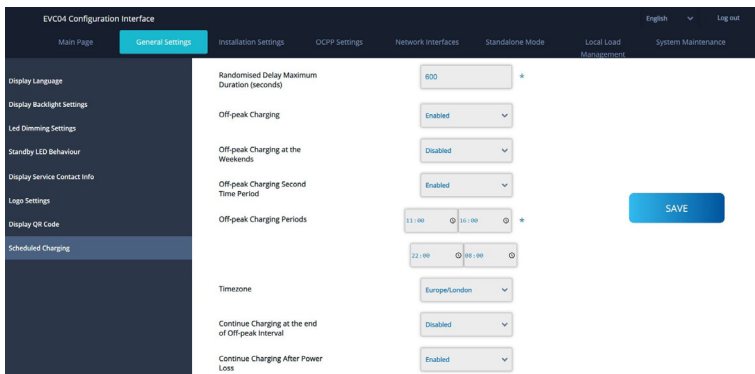

6.6.3 - INSTALLATION SETTINGS

6.6.3.1 - Earthing system

Earthing System Tab in web configuration interface. If Earthing Type is selected as IT, the protective earth error check is disabled. In web configuration interface, earthing type is "TN/TT" by default.

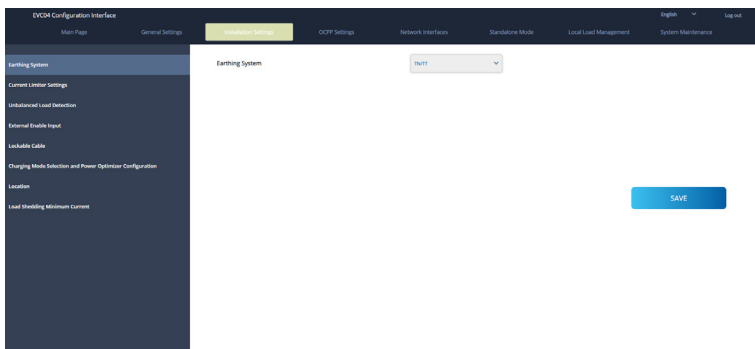

6.6.3.2 - Current Limiter Settings

Current Limiter Phase information can be adjusted in this menu. Also Current Limiter Value can be written manually between 6-32A. If a value below 6A is written, a warning will be shown to write minimum 6A.

Note: For example, if the charging station's current limiter is set to 16A in hardware and it is written and set 32A in web configuration interface, the station takes 16A.

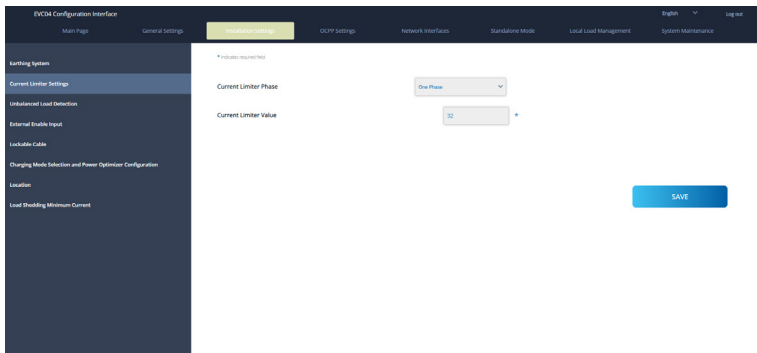

6.6.3.3 - Unbalanced Load Detection

This feature is disabled in webconfiguration interface by default. Unbalanced load detection function detects too much difference in power drawn between phases.If any phase draws more than 4.6 kW of power (last one minute average) than the other phases,there is an unbalanced load. With this feature, this situation is detected and current limitation is made so that the phases does not exceed this limit value.

For example,

Phase 1 Power :3 kW,

Phase 2 Power :3 kW,

Phase 3 Power: 1 kW.

Power Limit for Phase1 or Phase2 will be 5,6 kW (1 kW + 4.6 kW)

If voltage is 230, current limit will be $5600/230 = 24A$.

General Formula;

Power Limit = (Minimum Power + 4.6) (kW)

Current limit = Power Limit / Voltage (Amps)

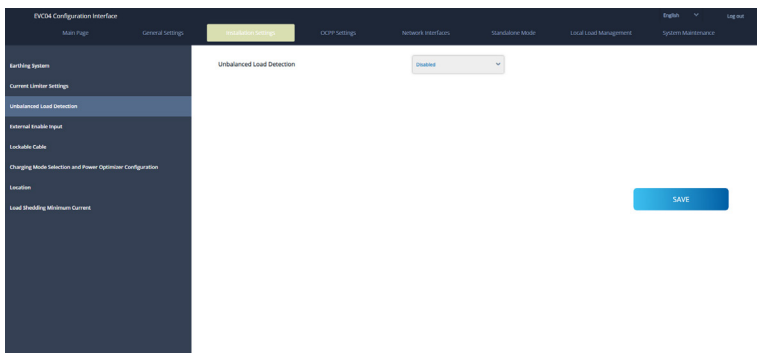

6.6.3.4 - External Enabled Input

Default value for this option is set as disabled but if the user wants to use external enable input function, the setting should be set as “enabled”.

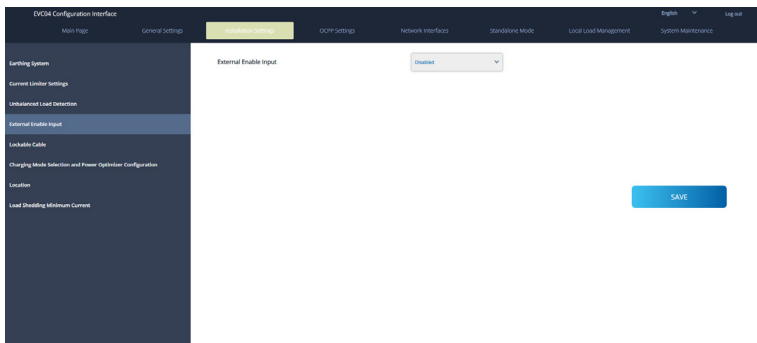

6.6.3.5 - Lockable Cable

This option is set “disabled” in web configuration user interface by default.

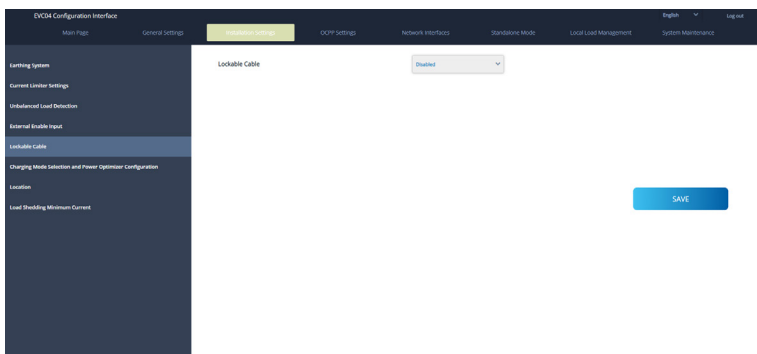

6.6.3.6 - Charging Mode Selection and Power Optimizer Configuration

For Power Optimizer Total Current Limit, The value mentioned in section “POWER OPTIMIZER” can be set from web configuration interface as shown in figure below.

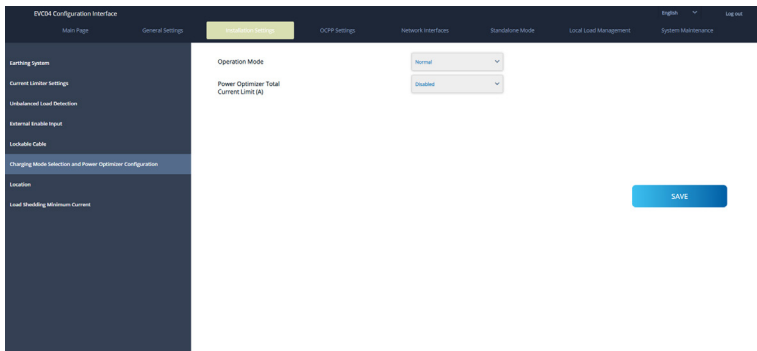

6.6.3.7 - Location

In this part, you can select Location from Web configuration. Options are Indoor and Outdoor.

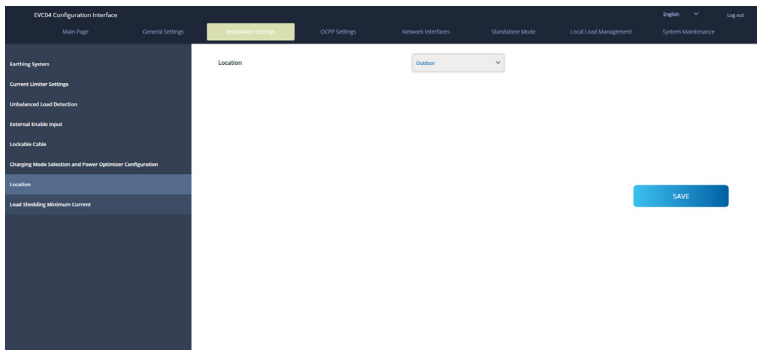

6.6.3.8. - Load Shedding Minimum Current:

In this part, you can select Load Shedding Minimum Current from Web configuration. This parameter can take values between 0 and Current Limiter Value. Current Limiter Value can be set on Current Limiter Settings.

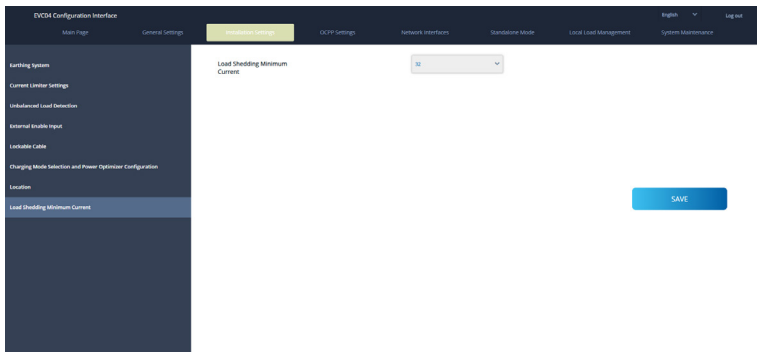

6.6.4 - CHANGE OCPP SETTINGS OF THE DEVICE

OCPP Connection: If you select mode as “Enabled”; you should type all fields in the connection settings and configuration parameters sections are enable in the below.

For now, the only available OCPP version is OCPP 1.6, so it will be selected as default.

The Central System Address and Charge Point Id are mandatory fields for saving this page.

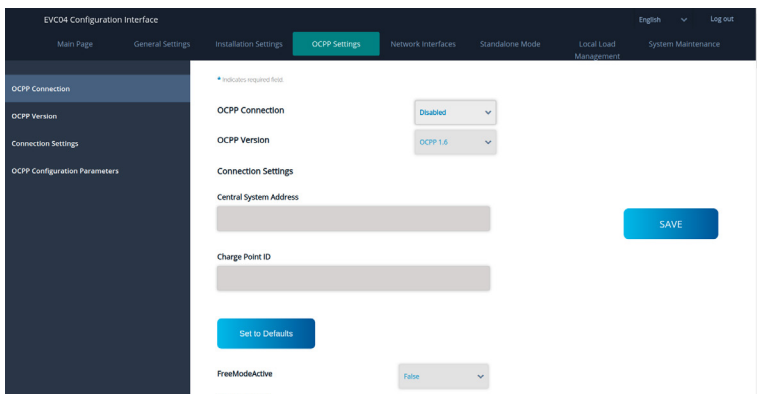

You can set OCPP configuration parameters to their default values by clicking “Set to Defaults” button. You can select the OCPP settings type you want from the menu which is at the left side of the page. For example OCPP Connection, OCPP Version, Connection Settings and OCPP Configuration Parameters. Then, click “Save” button.

Please be careful for your entered values because the system does not accept the unsuitable values and gives the warning. In this case, values will not be saved. Then the page does not be redirected the main page so you should check your values.

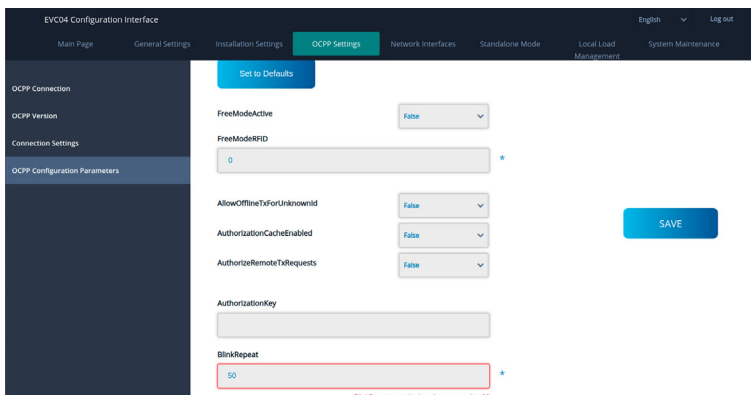

Also if you make changes and you don't save them before the leaving that page, you will see the warning as shown below.

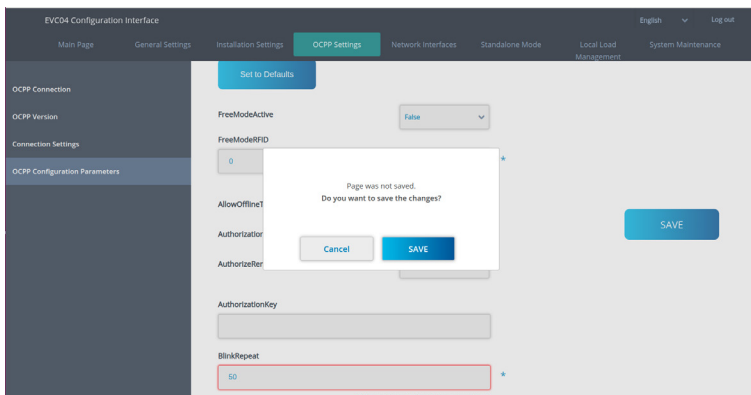

6.6.5 - CHANGE NETWORK INTERFACES SETTINGS OF THE DEVICE

There are four types of network interfaces in this page; Cellular, Ethernet, Wi-Fi and Wi-Fi Hotspot. Select interfaces' modes as "Enabled" if you want to activate it.

If you select Ethernet or Wi-Fi IP Settings as "Static"; "IP Address", "Network Mask", Default Gateway" and "Primary DNS" spaces are mandatory.

If you set Wi-Fi as enabled, "SSID", "Password" and "Security" are mandatory.

You should fill all spaces in suitable formats.

CELLULAR

The screenshot shows the 'Network interfaces' tab in the EVC04 Configuration Interface. The 'Cellular' interface is selected in the left sidebar. The main content area displays the following settings:

- Cellular:** Enabled (dropdown menu)
- Cellular Gateway:** Disabled (dropdown menu)
- IMEI:** 860425046096296
- IMS:** (empty text field)
- ICCID:** (empty text field)
- APN Name:** (empty text field)
- APN Username:** (empty text field)

A blue 'SAVE' button is located on the right side of the form.

LAN

The screenshot shows the 'Network interfaces' tab in the EVC04 Configuration Interface. The 'LAN' interface is selected in the left sidebar. The main content area displays the following settings:

- LAN:** (header)
- MAC Address:** 68:47:49:72:50:20
- IP Setting:** Static (dropdown menu)
- IP Address:** 192.168.0.10
- Network Mask:** 255.255.255.0
- Default Gateway:** (empty text field)

A blue 'SAVE' button is located on the right side of the form.

WLAN

The screenshot shows the 'WLAN' configuration page in the EVCO4 Configuration Interface. The interface has a dark theme with a sidebar on the left containing 'Cellular', 'LAN', 'WLAN', and 'Wi-Fi Hotspot'. The 'WLAN' option is selected. The main content area is titled 'Network Interfaces' and includes a 'WLAN' section with the following fields:

- WLAN**: Enabled (dropdown)
- MAC Address**: CC:03:C1:01:95:BF (text input)
- SSID**: (text input)
- Password**: (text input)
- Security**: Select security type (dropdown)
- IP Setting**: Please select IP setting (dropdown)

A blue 'SAVE' button is located on the right side of the form.

When you finish it, click “Save” button.

WIFI HOTSPOT

Details are described in section “OPENING WEB CONFIGURATION INTERFACE VIA WIFI HOTSPOT”

The screenshot shows the 'Wi-Fi Hotspot' configuration page in the EVCO4 Configuration Interface. The interface has a dark theme with a sidebar on the left containing 'Cellular', 'LAN', 'WLAN', and 'Wi-Fi Hotspot'. The 'Wi-Fi Hotspot' option is selected. The main content area is titled 'Network Interfaces' and includes a 'Wi-Fi Hotspot' section with the following fields:

- Turn on during boot**: Enabled (dropdown)
- Auto turn off timeout**: 5 (dropdown)
- SSID**: (text input)
- Password**: (text input)

A blue 'SAVE' button is located on the right side of the form.

6.6.6 - CHANGE STANDALONE MODE SETTINGS OF THE DEVICE

If you have set OCPP as enabled in OCPP settings before, standalone mode cannot be selected. The mode list and “Save” button will be disabled in this situation.

Otherwise, you can select standalone mode from the list. There are three modes in the list;

Select “RFID Local List” mode to authenticate a RFID local list which will be entered by you. You can make an addition or deletion from the RFID local list later.

Select “Accept All RFID’s” mode to authenticate all RFID’s.

Select “Autostart” mode to allow charging without the need for authorization. It will be enough to plug to start charging.

If you are done with mode selection, click “Save” button and reboot the device.

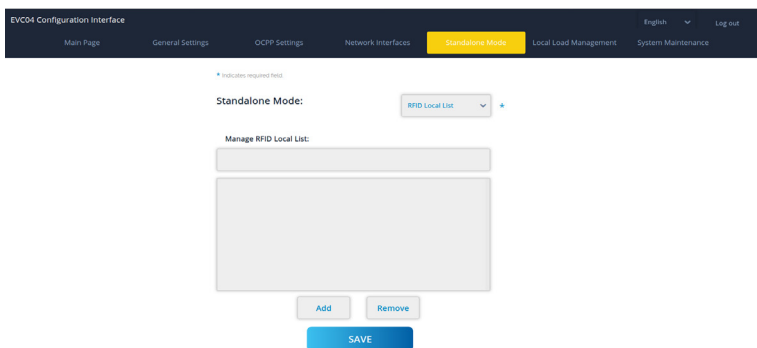
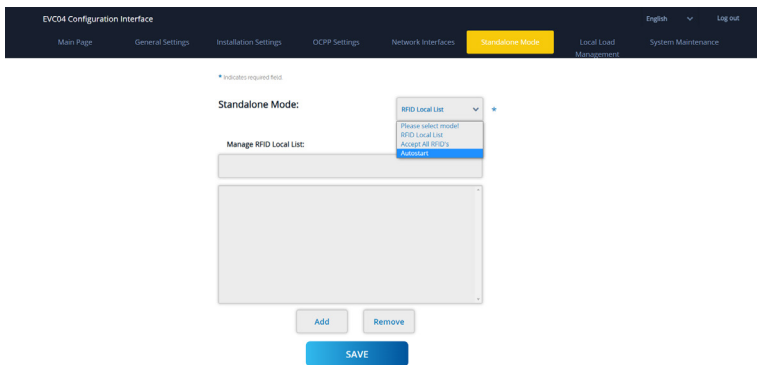

6.6.7 - LOCAL LOAD MANAGEMENT OF THE DEVICE

6.6.7.1 - Modbus TCP/IP Protocol Parameters

EVC04 charging station acts as a slave device in the Modbus TCP/IP communication. Charging station should be in the same network with the master device or a proper routing should be applied to provide communication between slave and the master devices in different sub networks. Each charging station should have different IP address. Modbus TCP communication port number is 502 and Modbus Unit ID is 255 for EVC04 charging stations. There can be only one active Modbus master connection at any time. When a new Modbus connection is established, the master is expected to set the Failsafe Current, Failsafe Timeout and Charging Current registers immediately. The master also periodically sets the Alive register to indicate that the connection is still alive. If the master does not update the value of the alive register until the failsafe timeout, the device switches to the failsafe state; TCP socket is terminated and failsafe current becomes active. As the update period of the Alive register, half of the failsafe timeout is recommended.

6.6.7.2 - Static Management

For static management, a power limit can be set to the load management group and the charger won't go above the power limit.



6.6.7.3 - Dynamic Management

With the help of dedicated power optimizer option, EV Charging station can manage the power limit based on the available power. When the household appliances consumes more, the charger consumes less and doesn't overload the main switch.

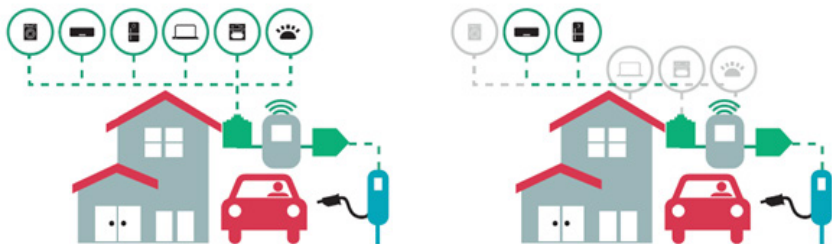

There are 2 different types of network topologies available for connecting multiple EVC04 charging stations in master/slave clusters. According to the customer needs, one of these alternatives can be chosen.

6.6.7.4 - Star Topology

In star network topology, all chargers are connected to the master station via a network switch or router. This topology needs cabling between each charging station and the central switch. This topology is more reliable than daisy chain topology since each charging station has its own connectivity to the network switch. For connection of each station to the central switch, Cat5e or Cat6 Ethernet cables can be used up to 100 meters each.

For the IP configuration of the network, either the router may have DHCP server or the master charging station can be configured as DHCP server. If you use a router with a DHCP server, you need to configure all charging stations including the master station LAN IP address setting as “Dynamic” from “Network Interfaces” menu. In this scenario, all the charging stations get their IP addresses from central DHCP server.

If you use a router or a L2-switch without DHCP server, you need to configure master charging station LAN IP settings to DHCP server and slave charging station LAN IP setting to “Dynamic” from “Network Interfaces” menu. In this scenario, slave charging stations get their IP addresses from master charging station.

Block diagrams for static and dynamic supply in star network topology are provided as below.

6.6.7.4.1 - Static Supply Star Topology:

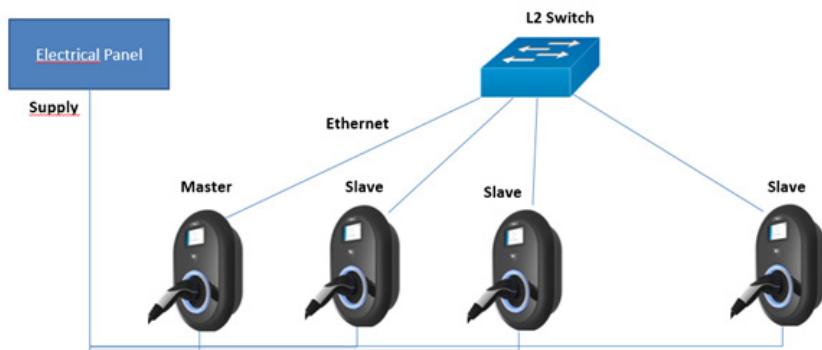

Local Load Management configuration of static supply.

6.6.7.4.2 - Dynamic Supply Star Topology:

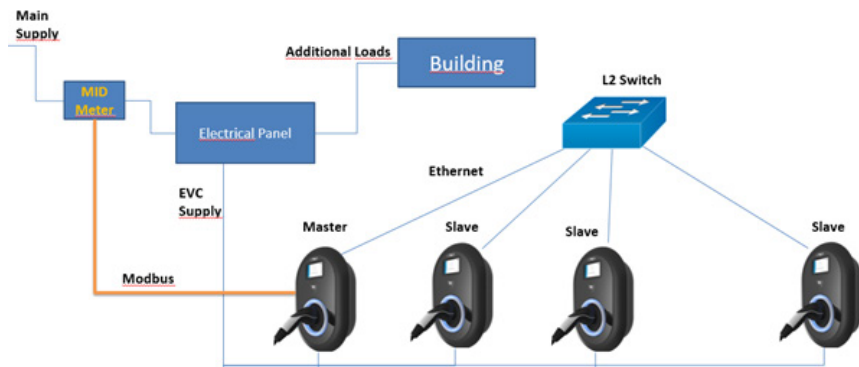

6.6.7.5 - Daisy Chain (Serial)

Daisy chain topology needs cabling between each charging station as in and out connection. To be able to use daisy chain topology, the charging station needs optional daisy chain two port switch board inside. For the connection of each charging station in series topology, Cat5e or Cat6 Ethernet cables can be used up to 100 meters each.

For the IP configuration of the network, master charging station should be configured as DHCP server. You need to configure slave charging stations' LAN IP address setting as "Dynamic" from "Network Interfaces" menu. In this scenario, all the charging stations get their IP addresses from the DHCP server inside master charging station.

Block diagrams for static and dynamic supply in daisy chain network topology are provided as below.

6.6.7.5.1 - Static Supply Daisy Chain Topology:

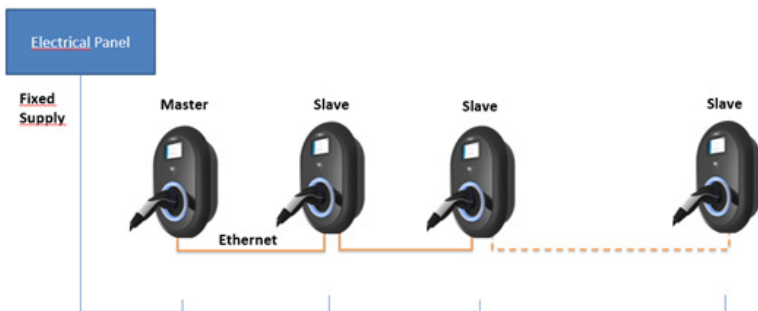

6.6.7.5.2 - Dynamic Supply Daisy Chain Topology:

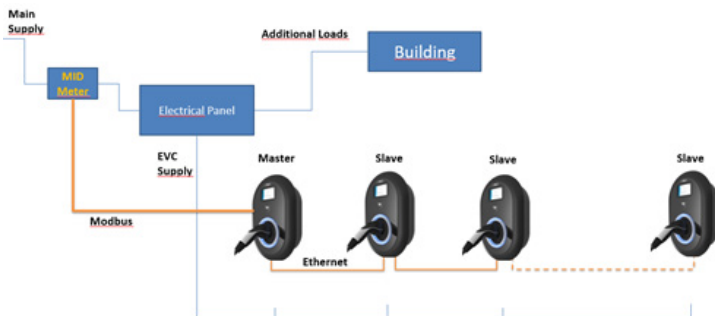
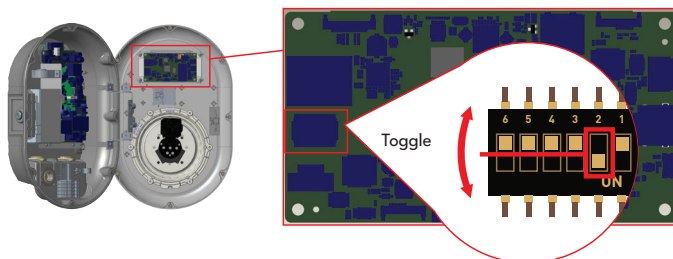

Figure-69

6.6.7.5.3 - Configuration of Slave Charging Stations

The charging station is preconfigure to DHCP mode in factory. If you need to connect to the charging station's web configuration interface directly using a computer, rather than using a router having DHCP server, steps below should be followed:

- Make sure the charging station is powered-off and open the front cover of your charger which is mentioned in installation guideline.
- Toggle the second position of DIP switch which is on the smart board of the charger shown in figure-below After that please turn on the charger again.
- Charging station sets the Ethernet port to 192.168.0.10 address statically and subnet mask will be set to 255.255.255.0



Open your web browser and type 192.168.0.10 which is IP address of smart board.

You will see login page on your browser;

When you want to enter to the web configuration interface in the first time, you will see the warning as “We recommend you to change your default password from system maintenance menu”.

You can enter the system with:

Default username = admin

Default password = admin

You can change password with Change Password Button in login page or Administration Password section in the System Maintenance tab.

Attention: For web configuration interface accessibility problems; Web browsers usually save some information from websites in its cache and cookies. Forcing Refresh or Clearing (depending on your operating system and browser) them fixes certain problems, like loading or formatting issues on web page.

Load management option is “disabled” by default. After accessing to configuration web interface, you need to tab “Local Load Management” menu and select “Master/Slave” in “Load management Option”. “Charge Point Role” should be selected as “Slave” as shown in below menus.

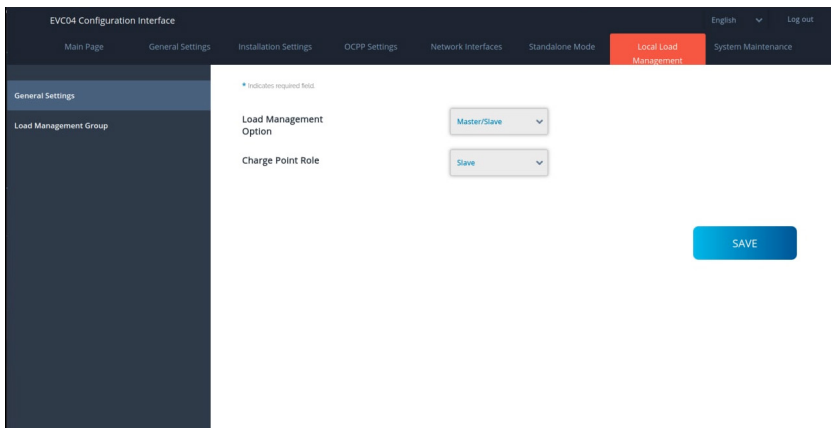
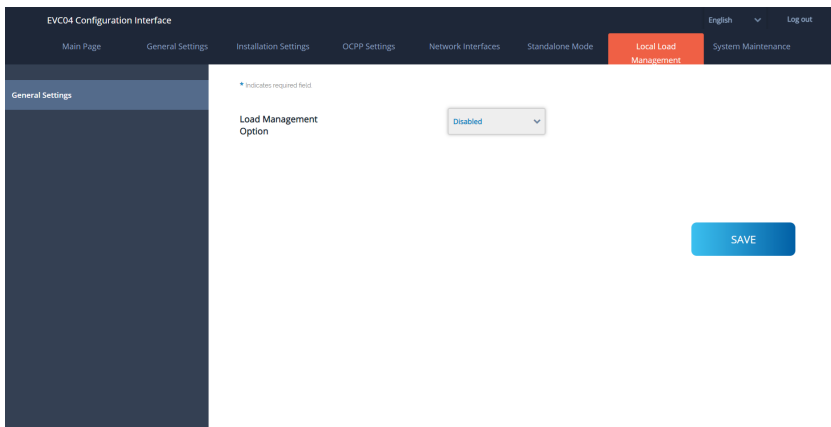

The slave charging stations should be set as DHCP client as shown in image below. Note that, this setting causes disconnection from configuration web interface of the charging station, so this setting should be the latest setting in slave configuration of the charging station.

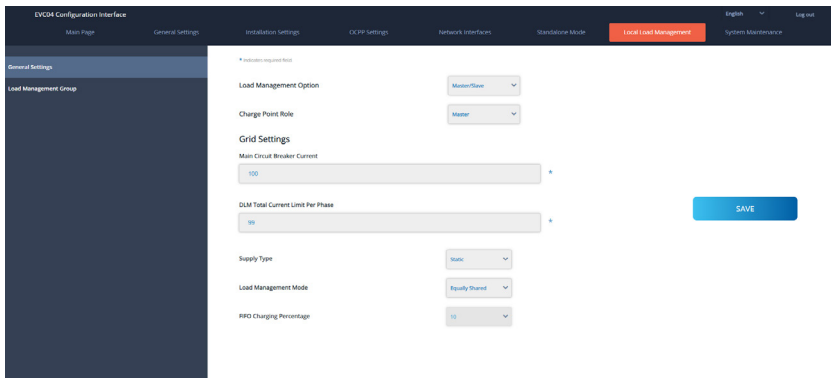

6.6.7.5.4 - Configuration of Master Charging Station

The charging station is preconfigure to DHCP mode in factory. If you need to connect to the charging station's web configuration interface directly using a computer, rather than using a router having DHCP server, steps below should be followed:

- Make sure the charging station is powered-off and open the front cover of your charger which is mentioned in installation guideline.
- Toggle the second position of DIP switch which is on the smart board of the charger shown in figure below After that please turn on the charger again.
- Charging station sets the Ethernet port to 192.168.0.10 address statically and subnet mask will be set to 255.255.255.0

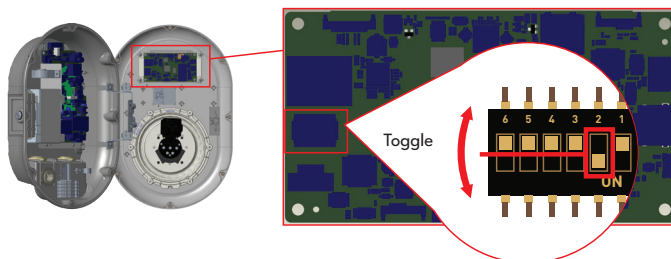

Open your web browser and type 192.168.0.10 which is IP address of smart board.

You will see login page on your browser;

When you want to enter to the web configuration interface in the first time, you will see the warning as “We recommend you to change your default password from system maintenance menu”.

You can enter the system with:

Default username = admin

Default password = admin

You can change password with Change Password Button in login page or Administration Password section in the System Maintenance tab.

Attention: For web configuration interface accessibility problems; Web browsers usually save some information from websites in its cache and cookies. Forcing Refresh or Clearing (depending on your operating system and browser) them fixes certain problems, like loading or formatting issues on web page.

The master charging station should be set as DHCP server with a valid static IP address E.g. 192.168.0.10 with DHCP start and end IP addresses 192.168.0.50 and 192.168.0.100, respectively, as shown in the image below.

Note that if there is an external DHCP server in the local network, you also need to set master charging station to DHCP client.

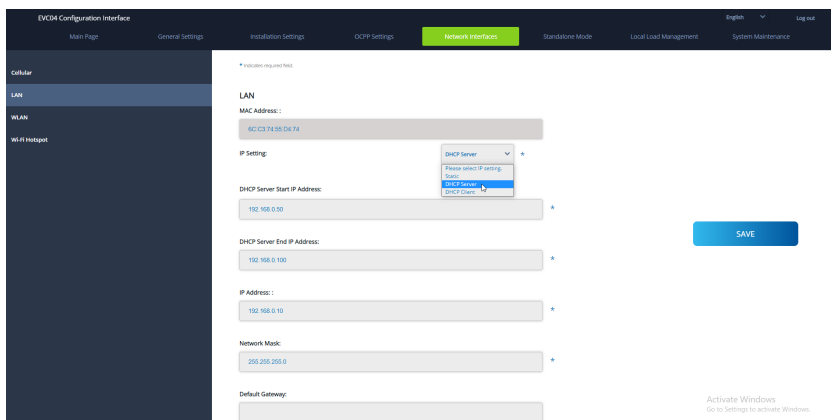

Load management option is “disabled” by default. After accessing to configuration web interface, you need to tab “Local Load Management” menu and select “Master/Slave” in “Load management Option”. “Charge Point Role” should be selected as “Master” as shown in the image below.

EVCharging Configuration Interface

Main Page General Settings Installation Settings OCPP Settings Network Interfaces Standalone Mode **Local Load Management** System Maintenance English Log out

General Settings

Load Management Group

* Indicates required field

Load Management Option Master/Slave

Charge Point Role Master

Grid Settings

Main Circuit Breaker Current 100

DLM Total Current Limit Per Phase 99

Supply Type Static

Load Management Mode Equally Shared

RFD Charging Percentage 95

SAVE

Master charging station has additional configuration settings for dynamic load management group. “DLM Total Current Limit Per Phase ” value should be set to the maximum allowed current which can be drawn from the upstream electrical circuit.

“Supply Type” should be set according to the load management type such as “static” current limit or “dynamic” current limit. For static current limit, “static” option should be selected. For dynamic current measurement, “MID” should be selected in “supply type”. Note that dynamic current limit setting needs optional current measurement accessories.

EVCharging Configuration Interface

Main Page General Settings Installation Settings OCPP Settings Network Interfaces Standalone Mode **Local Load Management** System Maintenance English Log out

General Settings

Load Management Group

* Indicates required field

Load Management Option Master/Slave

Charge Point Role Master

Grid Settings

Total Current Limit Per Phase 99

Supply Type Static

Load Management Mode Equally Shared

RFD Charging Percentage 95

SAVE

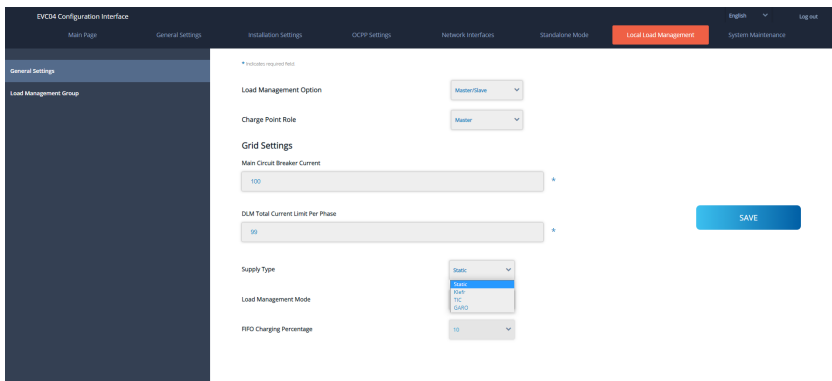

Appropriate load management mode can be selected from three options as “Equally shared”, “First in First out” and “Combined” modes. Combined mode needs extra configuration as “Fifo Charging Percentage” which effects the share between equally shared and first-in first-out calculations of the load management algorithm.

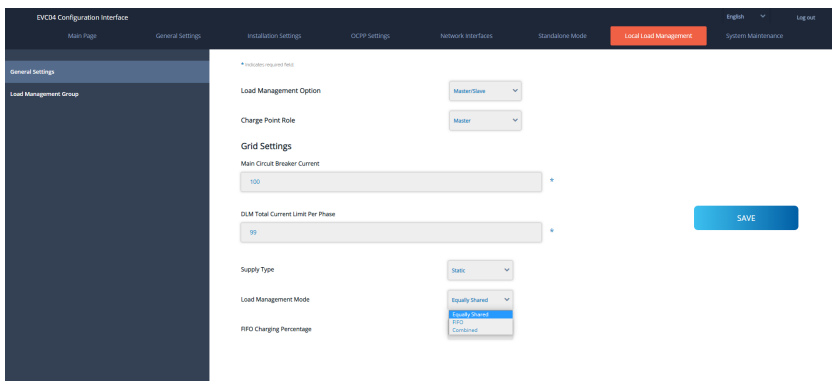

There are 3 different scenarios of load management usage:

6.6.7.6 - Equally shared

All available power is distributed equally to all EVs connected. This is more suitable for workplace or condominium chargings where the cars are parked for a considerable period of time.

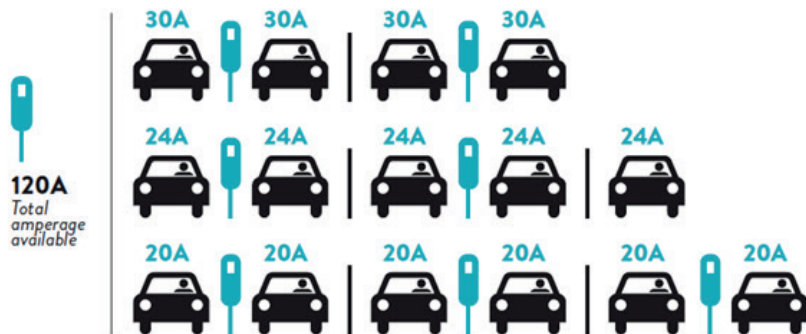

6.6.7.7 - FiFo (First in - First Out)

This type of load management is more oriented for fleets in order to let them have more fully charged EVs when they need. The available power is redistributed and when a new EV arrives, it waits until an EV finishes its charge or leaves the charging point.

EVSE\T _p	G _M =120A				G _M =80A		
	T ₁	T ₂	T ₃	T ₄	T ₅	T ₆	
1	32A	32A	32A	32A	16A	6A	6A
2	32A	32A	32A	32A	32A	32A	32A
3	32A	32A	32A	32A	32A	32A	32A
4	32A	24A	24A	18A	32A	32A	6A
5	32A	24A	6A	6A	8A	24A	6A

* T_p: Time Period, G_M = Maximum Grid allocated for the chargers. Available maximum current for each EVSE in a certain T_p is indicated in black color. Charging current which is drawn by EV is indicated in Blue color. An EV drawing less current is indicated by "!" symbol.

6.6.7.8 - Combined Load Management

Combined load management is a combination of FiFo and Equally shared methods. A percentage of total power allocated for EV charging cluster can be set and this percentage of total power distributed to all EVs according to FiFo and the remaining power will be delivered as equally shared principal to all EVs.

F%=50	G _M =120A						G _M =80A		G _M =29A	G _M =30A	
	EVSE T _p	T ₁	T ₂	T ₃	T ₄	T ₅	T ₆	T ₇	T ₈	T ₉	T ₁₀
1	32A	32A	32A	32A	32A	20A	6A	6A	8A		6A
2	32A	32A	32A	32A	32A	32A	32A	32A	32A	11A	6A
3	32A	32A	32A	32A	32A	32A	32A	26A	28A	6A	6A
4	32A	24A	24A	12A	24A	32A	8A	10A	6A	6A	
5	32A	24A	12A	12A	12A	18A	8A	10A	6A	6A	

* T_p: Time Period, G_M = Maximum Grid allocated for the chargers. Available maximum current for each EVSE in a certain T_p is indicated in black color. Charging current which is drawn by EV is indicated in Blue color. A EV drawing less current is indicated by "!" symbol.

After the basic load management configurations are finished, be sure to connect all of the slave charging stations to the master charging station through daisy chain or star network topology.

When all the charging stations are ready to communicate with the master charging station, click "UPDATE DLM GROUP" button in "Load Management Group" menu. When "UPDATE DLM GROUP" button is clicked, master charging station starts slave discovery mode and automatically finds and lists slave charging stations in the list including master charging station itself as connector.

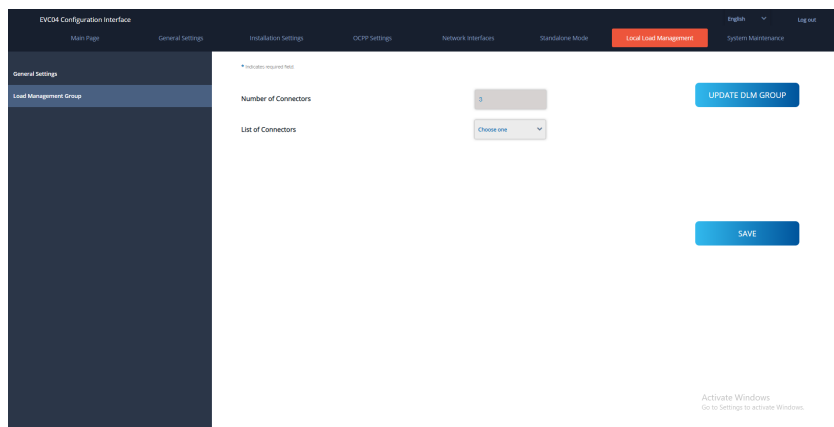

After master charging station discovers all the slave charging stations, then you can make other required settings of each connector one by one

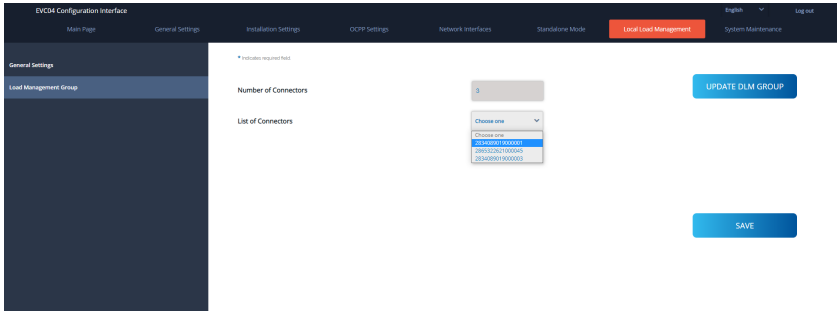

If the selected connector is required to be prioritized over the other charging stations, you can set “VIP Charging” as enabled as shown in the image below.

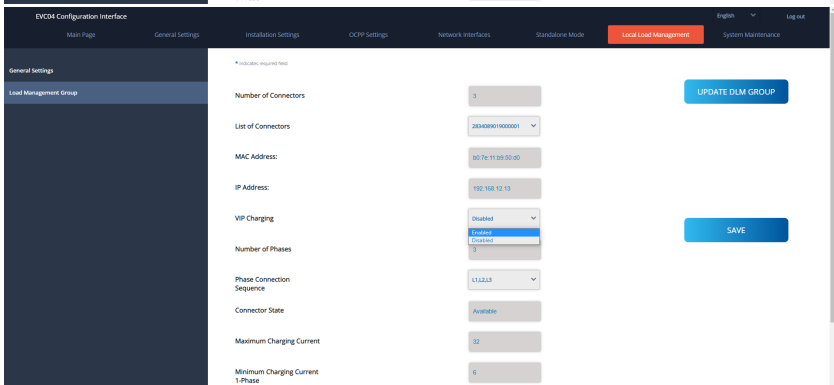
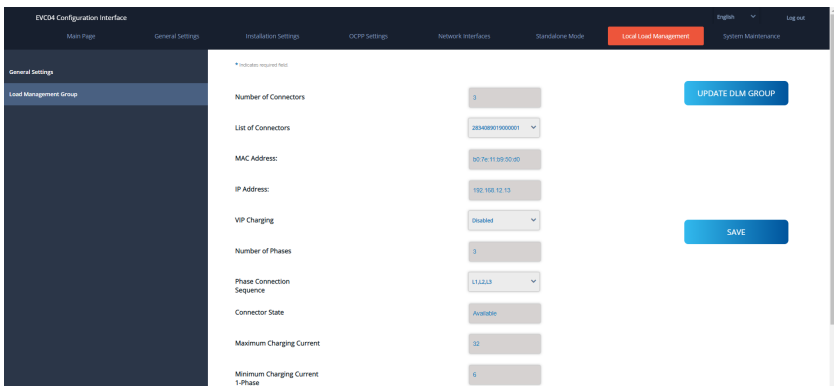

For setting the actual phase connection sequence of each charging station, you need to select correct sequence from the dropdown menu as shown in the image below.

Note that if the charging station has only one phase supply, then you just need to select correct phase number from the drop down menu.

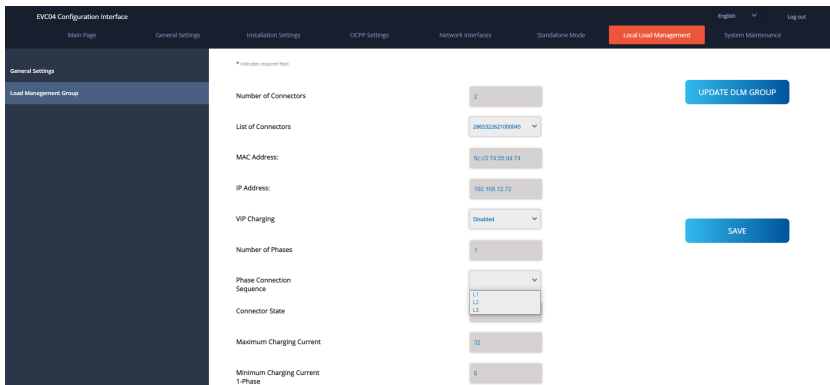

Other parameters are just read only information from the connectors, which can be updated to the latest values by refreshing the configuration web interface.

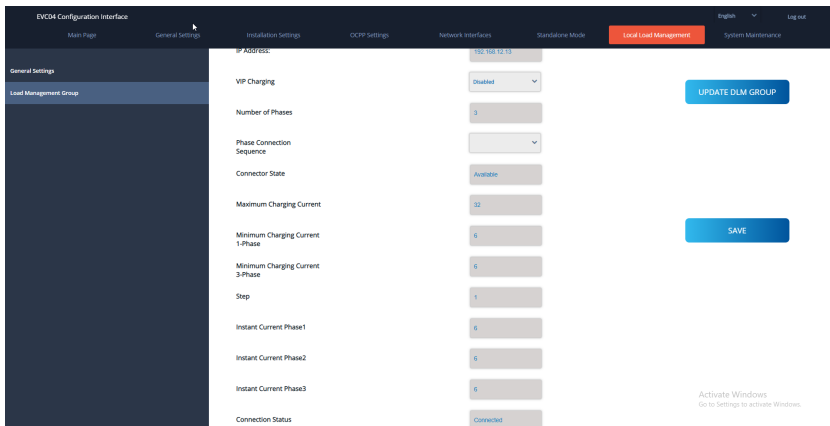

6.7.8 - MAKING SYSTEM MAINTENANCE OF THE DEVICE

On the LOG FILES page, OCPP or HMI logs can be downloaded by clicking on the buttons. The log files to be downloaded are displayed after a few seconds.

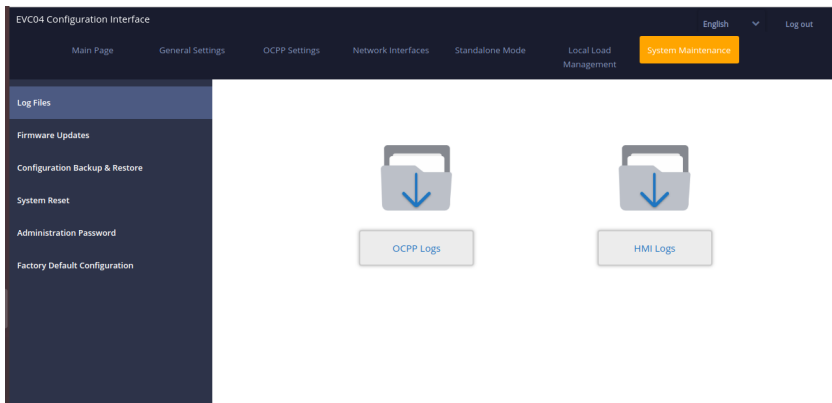

On the FIRMWARE UPDATE page, you can upload the firmware update file from your PC by clicking the 'Upload' button. After uploading the file, you can click on the 'Update' button to start the firmware update.

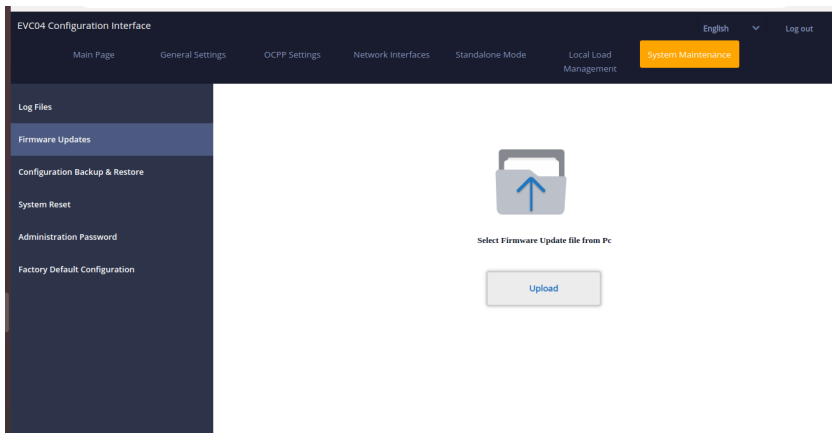

When the update is started, the charger LED turns constant red. If the charger had a display, you could see the firmware update screen on the display. See the Firmware Update Screen Flow section. When the firmware update is complete, the charger automatically restarts. You can view the latest firmware version of the loader from the webconfig user interface on the main page.

6.7.9 - FIRMWARE UPDATE SCREEN (With display models)

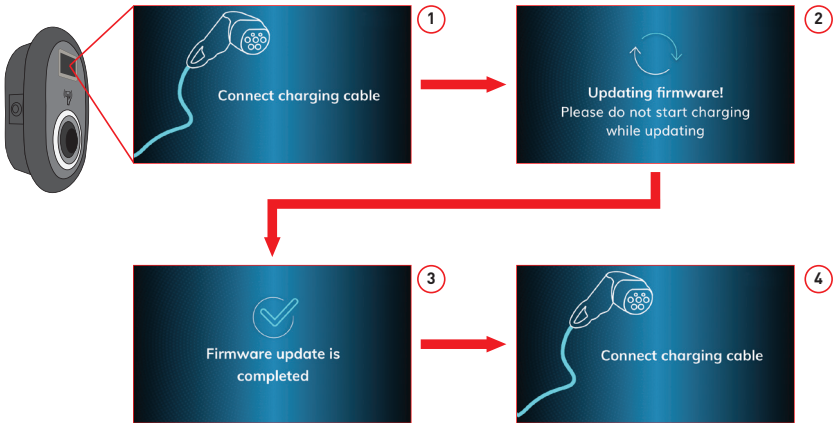

- 1- The firmware update is sent and the devices load it.
- 2- When the device software is in an update state.
- 3- After 5 seconds, the screen returns to the opening screen.
- 4- Connect the charging cable.

On the **CONFIGURATION AND BACKUP** page, the system can be backed up. If you wish to restore, you can click the 'Restore Config File' button and load the backup file. The system only accepts .bak files.

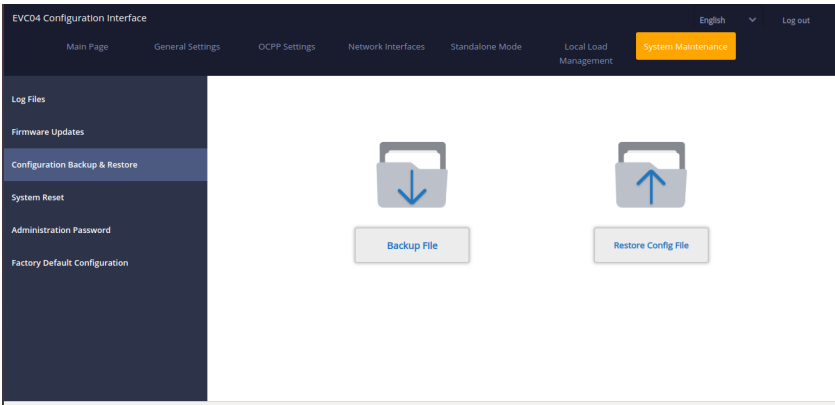

On the **SYSTEM RESET** page, you can perform Soft Reset and Hard Reset by clicking the buttons.

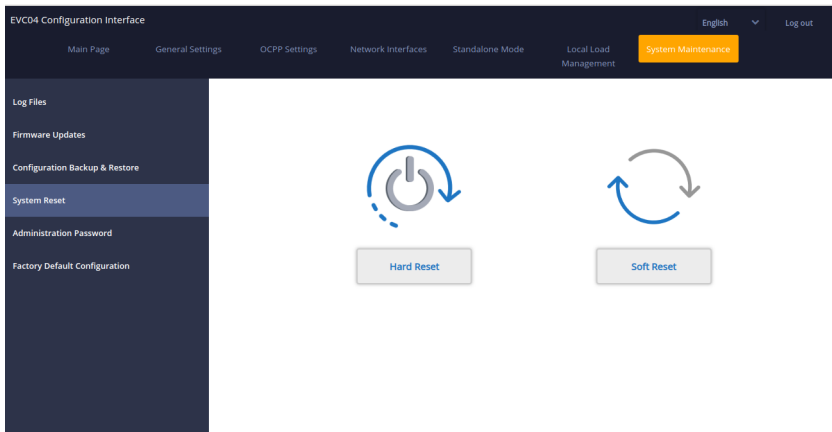

On the **ADMINISTRATION PASSWORD** page, you can change your web configuration access password. The new password must contain at least 1 lower case letter, 1 upper case letter, 1 numeric character and at least 6 characters. All spaces are mandatory.

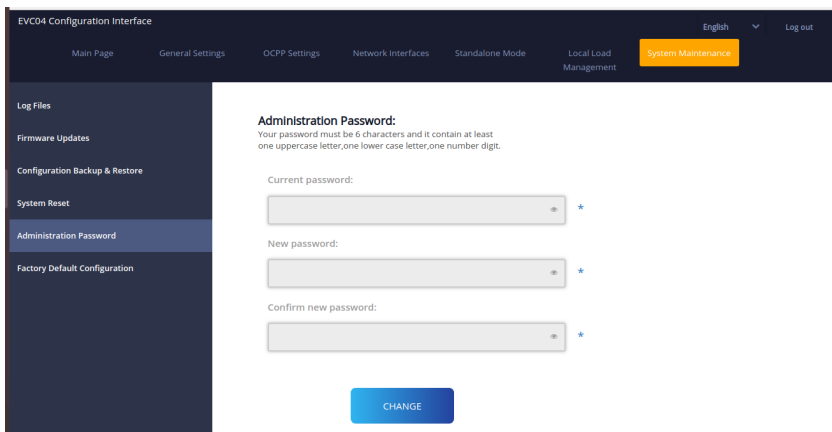

On the **FACTORY DEFAULT CONFIGURATION** page, it is possible to perform a factory reset of the device.

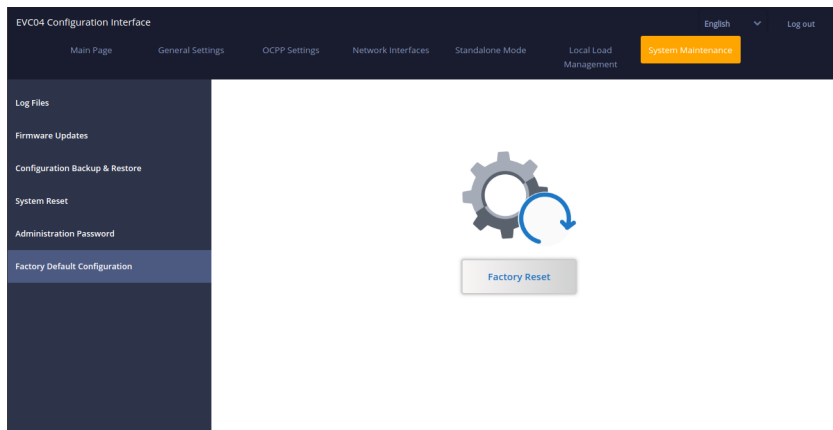

7 - UK REGULATION CHANGES ACCORDING TO SMART CHARGING (OPTIONAL)

CONFIGURATION WEB INTERFACE SETTINGS

Randomised Delay and Off-Peak Charging Behaviour

a. Randomised delay won't be repeated if applied in a charging period (except after power off and second transition to off peak hour, E.g: charging starts at 15:00 and paused at 16:00, when starting at 22:00 again randomized delay will be applied again.)

b. Randomised delay and waiting for off-peak charging will be cancelled if user tap RFID card for forced charging (first tap if charging station is in autostart mode, second tap if the charging station is in authorized mode). If the unit is in autostart mode any RFID card will force a charge, if the unit is in authorized mode the authorizing card of that charging session will force charge. Forced Charge will cancel both off-peak hour waiting period and randomized delay for that charging session.

c. While starting a charge session, if the time is in a peak period, the charging start will be delayed to the upcoming off-peak period start time. Randomized delay will be applied when the charging (actual energy transfer) starts.

d. If the time is in off-peak period, the randomized delay will be applied (if enabled) and then charging will start after delay. (It is only a numerical value and should be 600 by default). During the charging session if the time shifts from off-peak to peak, charging will continue or pause according to the setting "ContinueAfterOffPeakHour".

e. If unit has a screen "Waiting for off-peak hour, charging will start at hh:mm" will be shown on the screen as below while OCPP mode is active.

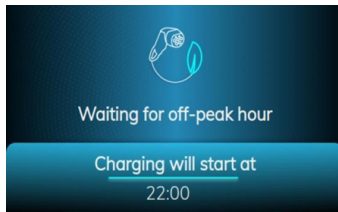

f. If unit has a screen, "Waiting for random delay, Charging will start at hh:mm" will be shown on the screen as below while OCPP mode and random delay mode are active sync of the time information from the server.

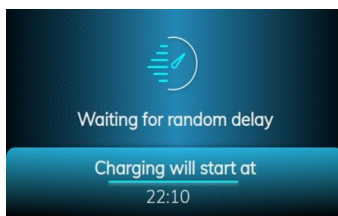

g.If a unit can connect to a central system, it will show exact charging start time on the screen. If a unit can not sync local time from the server due to either a connection issue or the unit is used locally without connection, it will only show the remaining time to start the charging session.

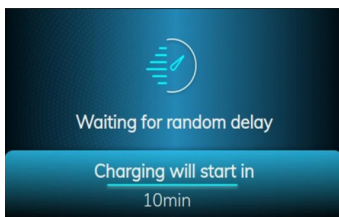

h.If unit does not have screen then waiting for off-peak hour will be shown on LED as Blue-Red blinking. (will be shut of after 5 mins)

i.If unit does not have a screen then randomised delay will be shown on LED as Green blinking.

OCPP mode change config items:

- i. RandomisedDelayMaxSeconds: [0, 1800] (default:600, can be set to “0” for disabling)
- ii. CurrentSessionRandomDelay: random delay value calculated for active charging session. The value will be decremented by 1 minute intervals with time passes. (subject to change)
- iii. OffPeakCharging: TRUE / FALSE (Default: TRUE)
- iv. OffPeakChargingWeekend: TRUE / FALSE (Default: FALSE)
- v. OffPeakChargingTimeSlots: 11:00-16:00, 22:00-08:00 (default: 11:00-16:00, 22:00-08:00)
- vi. ContinueAfterOffPeakHour: TRUE / FALSE (Default: FALSE)
- vii. ContinueChargingAfterPowerLoss: TRUE / FALSE (Default: TRUE)
- viii. ForcedCharging: TRUE / FALSE (Default: False, OCPP CS may set this to TRUE for overriding randomised delay and off-peak and after the charging session charging station will set this to FALSE again.)

Standalone / Local RFID List:

Webconfig General Settings menu “Smart Charging” tab:

- i. Randomised delay maximum duration (seconds) Editable for admin user, readonly for end user credentials [0, 1800] (default: 600, can be set to “0” for disabling)
 - ii. Off-peak Charging (Enabled / Disabled)
 - iii. Off-peak Charging at the Weekends (Enabled / Disabled) (default: Enabled for UK, Disabled for rest)
 - iv. Off-peak Charging Periods: 11:00-16:00, 22:00-08:00 (default: 11:00-16:00, 22:00-08:00)
 - v. Continue charging at the end of off-peak interval (Enabled / Disabled)
 - vi. Continue charging without re-authentication after power loss (Enabled / Disabled)
- Off-peak charging function will be active if and only if device is connected to the central system.

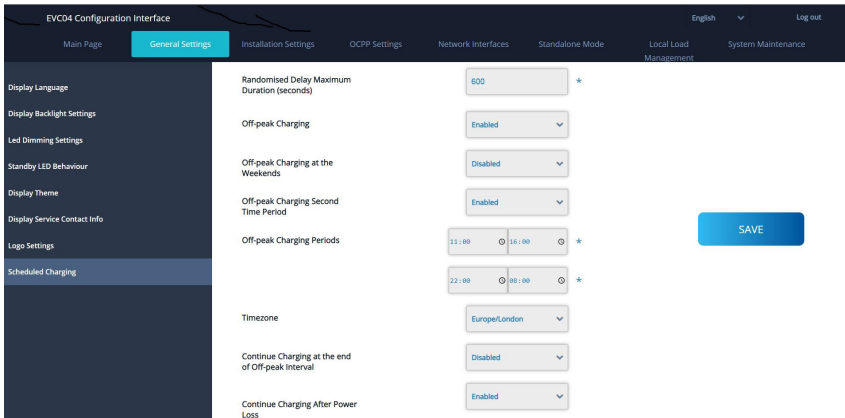

For the unit in standalone mode the settings will be as above. For Standalone modes, off peak charging will be hidden because of the time sync issue.

Randomised Delay Maximum Duration, can take values between 0 and 1800.

VESTEL

**VESTEL Holland B.V UK Branch,1 Waterside Drive,
Langley, Berkshire, SL3 6EZ**



50680678